



HAZET
INSTRUMENTS CO.

Hazet Instruments Co. Catalog

ARTERY FORCEPS

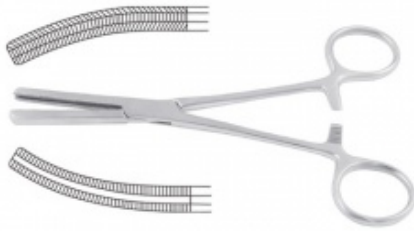

Angiotribes

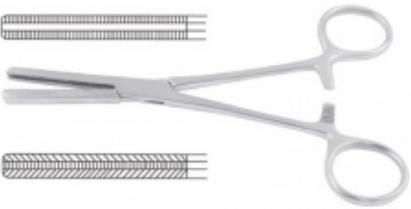
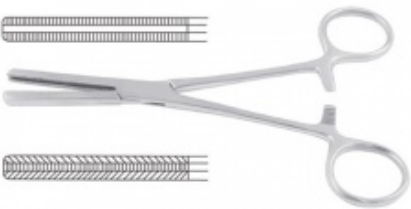
Product Image	Product Name	Price(\$)
	Angiotribes HIC-101	0.00
	Angiotribes HIC-102	0.00

	<p>Angiotribes HIC-103</p>	<p>0.00</p>
	<p>Angiotribes HIC-104</p>	<p>0.00</p>

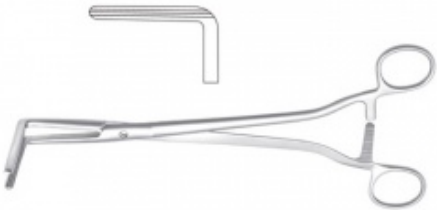
Atrauma Clamps

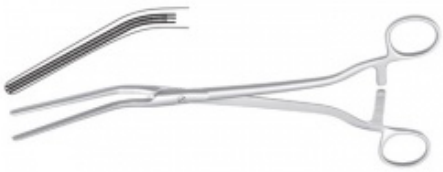
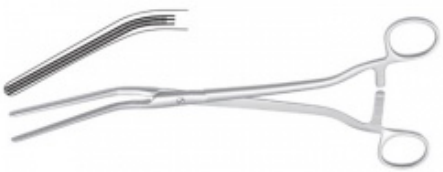
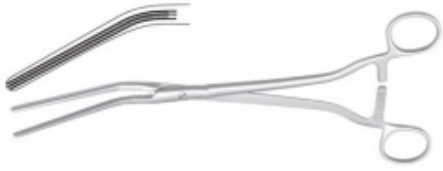

Product Image	Product Name	Price(\$)
	<p>Atrauma Clamps HIC-201</p>	<p>0.00</p>

 Atrauma Clamps HIC-202: A pair of surgical forceps with long, thin, slightly curved jaws and rounded handles.	Atrauma Clamps HIC-202	0.00
 Atrauma Clamps HIC-203: A pair of surgical forceps with long, thin, slightly curved jaws and rounded handles.	Atrauma Clamps HIC-203	0.00
 Atrauma Clamps HIC-204: A pair of surgical forceps with long, thin, slightly curved jaws and rounded handles.	Atrauma Clamps HIC-204	0.00
 Atrauma Clamps HIC-205: A pair of surgical forceps with long, thin, curved jaws and rounded handles.	Atrauma Clamps HIC-205	0.00



	<p>Atrauma Clamps HIC-206</p>	<p>0.00</p>
	<p>Atrauma Clamps HIC-207</p>	<p>0.00</p>
	<p>Atrauma Clamps HIC-208</p>	<p>0.00</p>

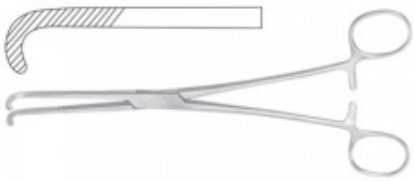



Bile Duct Clamps

Product Image	Product Name	Price(\$)





 A pair of surgical forceps with a long, thin, curved shaft and a textured grip on the upper handle. The lower handle is straight with a circular ring. The jaws are long and thin, tapering to a point.	<p>Bile Duct Clamps HIC-301</p>	<p>0.00</p>
 A pair of surgical forceps with a long, thin, curved shaft and a textured grip on the upper handle. The lower handle is straight with a circular ring. The jaws are long and thin, tapering to a point.	<p>Bile Duct Clamps HIC-302</p>	<p>0.00</p>
 A pair of surgical forceps with a long, thin, curved shaft and a textured grip on the upper handle. The lower handle is straight with a circular ring. The jaws are long and thin, tapering to a point.	<p>Bile Duct Clamps HIC-303</p>	<p>0.00</p>
 A pair of surgical forceps with a long, thin, curved shaft and a textured grip on the upper handle. The lower handle is straight with a circular ring. The jaws are long and thin, tapering to a point.	<p>Bile Duct Clamps HIC-304</p>	<p>0.00</p>

Bulldog Clamps

Product Image	Product Name	Price(\$)
 A pair of silver bulldog clamps with a serrated metal band.	Bulldog Clamps 401	0.00
 A pair of silver bulldog clamps with a serrated metal band.	Bulldog Clamps HIC-402	0.00
 A pair of silver bulldog clamps with a serrated metal band.	Bulldog Clamps HIC-403	0.00





	<p>Bulldog Clamps HIC-404</p>	<p>0.00</p>
	<p>Bulldog Clamps HIC-405</p>	<p>0.00</p>
	<p>Bulldog Clamps HIC-406</p>	<p>0.00</p>
	<p>Bulldog Clamps HIC-407</p>	<p>0.00</p>



	<p>Bulldog Clamps HIC-408</p>	<p>0.00</p>
	<p>Bulldog Clamps HIC-409</p>	<p>0.00</p>
	<p>Bulldog Clamps HIC-410</p>	<p>0.00</p>
	<p>Bulldog Clamps HIC-411</p>	<p>0.00</p>

 A pair of bulldog clamps, model HIC-412, consisting of a metal handle with a circular ring at the end and a curved, serrated jaw. A small metal component is shown above the handle.	<p>Bulldog Clamps HIC-412</p>	<p>0.00</p>
 A pair of bulldog clamps, model HIC-413, consisting of a metal handle with a circular ring at the end and a curved, serrated jaw. A small metal component is shown above the handle.	<p>Bulldog Clamps HIC-413</p>	<p>0.00</p>
 A pair of bulldog clamps, model HIC-414, featuring a long, straight handle with a circular ring at the end and a curved, serrated jaw.	<p>Bulldog Clamps HIC-414</p>	<p>0.00</p>
 A pair of bulldog clamps, model HIC-415, featuring a long, straight handle with a circular ring at the end and a curved, serrated jaw. A small metal component is shown above the handle.	<p>Bulldog Clamps HIC-415</p>	<p>0.00</p>



	<p>Bulldog Clamps HIC-416</p>	<p>0.00</p>
	<p>Bulldog Clamps HIC-416</p>	<p>0.00</p>
	<p>Bulldog Clamps HIC-417</p>	<p>0.00</p>
	<p>Bulldog Clamps HIC-418</p>	<p>0.00</p>

 A 3D rendering of a bulldog clamp, model HIC-419. The clamp consists of two long, tapered jaws that meet at a central pivot point. One jaw has a curved, hook-like tip. The handle is a single piece with a textured grip area and a smooth end.	<p>Bulldog Clamps HIC-419</p>	<p>0.00</p>
 A 3D rendering of a bulldog clamp, model HIC-420. The clamp features two long, tapered jaws with a straight tip. The handle is a single piece with a textured grip area and a smooth end.	<p>Bulldog Clamps HIC-420</p>	<p>0.00</p>
 A 3D rendering of a bulldog clamp, model HIC-421. The clamp has two long, tapered jaws with a straight tip. The handle is a single piece with a textured grip area and a smooth end.	<p>Bulldog Clamps HIC-421</p>	<p>0.00</p>
 A 3D rendering of a bulldog clamp, model HIC-422. The clamp has two long, tapered jaws with a straight tip. The handle is a single piece with a textured grip area and a smooth end.	<p>Bulldog Clamps HIC-422</p>	<p>0.00</p>

 A 3D CAD model of a bulldog clamp, model HIC-423. The clamp is shown in a closed position, with a long, thin metal rod inserted through the center. The handle is a light blue color with a textured grip. The clamp body is a darker blue color.	<p>Bulldog Clamps HIC-423</p>	<p>0.00</p>
 A 3D CAD model of a bulldog clamp, model HIC-424. The clamp is shown in a closed position, with a long, thin metal rod inserted through the center. The handle is a light blue color with a textured grip. The clamp body is a darker blue color.	<p>Bulldog Clamps HIC-424</p>	<p>0.00</p>
 A 3D CAD model of a bulldog clamp, model HIC-425. The clamp is shown in a closed position, with a long, thin metal rod inserted through the center. The handle is a light blue color with a textured grip. The clamp body is a darker blue color.	<p>Bulldog Clamps HIC-425</p>	<p>0.00</p>
 A 3D CAD model of a bulldog clamp, model HIC-426. The clamp is shown in a closed position, with a long, thin metal rod inserted through the center. The handle is a light blue color with a textured grip. The clamp body is a darker blue color.	<p>Bulldog Clamps HIC-426</p>	<p>0.00</p>





	<p>Bulldog Clamps HIC-427</p>	<p>0.00</p>
	<p>Bulldog Clamps HIC-428</p>	<p>0.00</p>
	<p>Bulldog Clamps HIC-429</p>	<p>0.00</p>
	<p>Bulldog Clamps HIC-430</p>	<p>0.00</p>





 A blue bulldog clamp with a long, pointed metal jaw and a blue plastic handle with a textured grip.	<p>Bulldog Clamps HIC-431</p>	<p>0.00</p>
 A silver metal bulldog clamp with two long, tapered jaws and a silver handle.	<p>Bulldog Clamps HIC-432</p>	<p>0.00</p>
 A silver metal bulldog clamp with two long, tapered jaws and a silver handle, identical to HIC-432.	<p>Bulldog Clamps HIC-433</p>	<p>0.00</p>
 A blue bulldog clamp with a long, pointed metal jaw and a blue plastic handle with a textured grip, identical to HIC-431.	<p>Bulldog Clamps HIC-434</p>	<p>0.00</p>

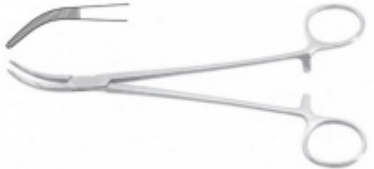



	<p>Bulldog Clamps HIC-435</p>	<p>0.00</p>
	<p>Bulldog Clamps HIC-436</p>	<p>0.00</p>



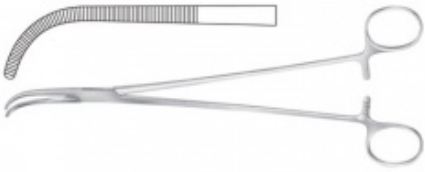

Dissecting and Ligature Forceps





Product Image	Product Name	Price(\$)
	<p>Dissecting and Ligature Forceps HIC-532</p>	<p>0.00</p>





	<p>Dissecting and Ligature Forceps HIC-531</p>	<p>0.00</p>
	<p>Dissecting and Ligature Forceps HIC-530</p>	<p>0.00</p>
	<p>Dissecting and Ligature Forceps HIC-529</p>	<p>0.00</p>
	<p>Dissecting and Ligature Forceps HIC-528</p>	<p>0.00</p>



	<p>Dissecting and Ligature Forceps HIC-527</p>	<p>0.00</p>
	<p>Dissecting and Ligature Forceps HIC-526</p>	<p>0.00</p>
	<p>Dissecting and Ligature Forceps HIC-525</p>	<p>0.00</p>
	<p>Dissecting and Ligature Forceps HIC-524</p>	<p>0.00</p>



	Dissecting and Ligature Forceps HIC-523	0.00
	Dissecting and Ligature Forceps HIC-522	0.00
	Dissecting and Ligature Forceps HIC-521	0.00
	Dissecting and Ligature Forceps HIC-520	0.00

	<p>Dissecting and Ligature Forceps HIC-519</p>	<p>0.00</p>
	<p>Dissecting and Ligature Forceps HIC-518</p>	<p>0.00</p>
	<p>Dissecting and Ligature Forceps HIC-517</p>	<p>0.00</p>
	<p>Dissecting and Ligature Forceps HIC-516</p>	<p>0.00</p>

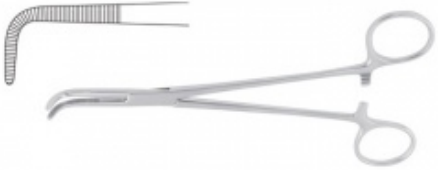

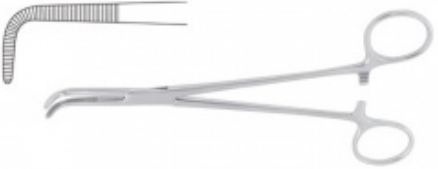
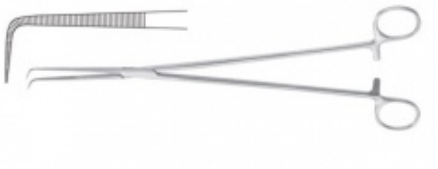
	<p>Dissecting and Ligature Forceps HIC-515</p>	<p>0.00</p>
	<p>Dissecting and Ligature Forceps HIC-514</p>	<p>0.00</p>
	<p>Dissecting and Ligature Forceps HIC-513</p>	<p>0.00</p>
	<p>Dissecting and Ligature Forceps HIC-512</p>	<p>0.00</p>



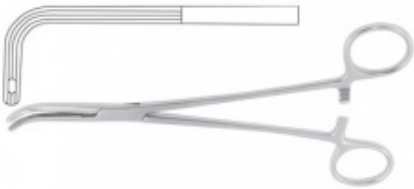

	<p>Dissecting and Ligature Forceps HIC-511</p>	<p>0.00</p>
	<p>Dissecting and Ligature Forceps HIC-510</p>	<p>0.00</p>
	<p>Dissecting and Ligature Forceps HIC-509</p>	<p>0.00</p>
	<p>Dissecting and Ligature Forceps HIC-508</p>	<p>0.00</p>





	<p>Dissecting and Ligature Forceps HIC-507</p>	<p>0.00</p>
	<p>Dissecting and Ligature Forceps HIC-507</p>	<p>0.00</p>
	<p>Dissecting and Ligature Forceps HIC-506</p>	<p>0.00</p>
	<p>Dissecting and Ligature Forceps HIC-505</p>	<p>0.00</p>



	<p>Dissecting and Ligature Forceps HIC-504</p>	<p>0.00</p>
	<p>Dissecting and Ligature Forceps HIC-501</p>	<p>0.00</p>
	<p>Dissecting and Ligature Forceps HIC-502</p>	<p>0.00</p>
	<p>Dissecting and Ligature Forceps HIC-503</p>	<p>0.00</p>





Hemostatic Forceps



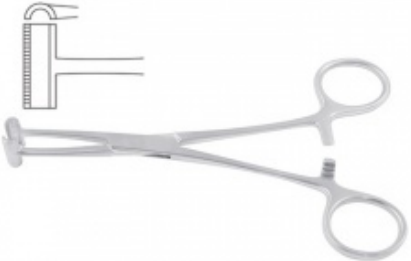

Product Image	Product Name	Price(\$)
 A pair of hemostatic forceps with curved jaws and serrated tips. A small inset image shows a close-up of the serrated tip.	Hemostatic Forceps HIC-651	0.00
 A pair of hemostatic forceps with curved jaws and serrated tips. A small inset image shows a close-up of the serrated tip.	Hemostatic Forceps HIC-650	0.00
 A pair of hemostatic forceps with curved jaws and serrated tips. A small inset image shows a close-up of the serrated tip.	Hemostatic Forceps HIC-649	0.00





	<p>Hemostatic Forceps HIC-648</p>	<p>0.00</p>
	<p>Hemostatic Forceps HIC-647</p>	<p>0.00</p>
	<p>Hemostatic Forceps HIC-646</p>	<p>0.00</p>
	<p>Hemostatic Forceps HIC-645</p>	<p>0.00</p>





	<p>Hemostatic Forceps HIC-644</p>	<p>0.00</p>
	<p>Hemostatic Forceps HIC-643</p>	<p>0.00</p>
	<p>Hemostatic Forceps HIC-642</p>	<p>0.00</p>
	<p>Hemostatic Forceps HIC-641</p>	<p>0.00</p>





	<p>Hemostatic Forceps HIC-640</p>	<p>0.00</p>
	<p>Hemostatic Forceps HIC-639</p>	<p>0.00</p>
	<p>Hemostatic Forceps HIC-638</p>	<p>0.00</p>
	<p>Hemostatic Forceps HIC-637</p>	<p>0.00</p>





 An illustration of Hemostatic Forceps HIC-636. The instrument consists of two long, tapered jaws with serrated inner surfaces. The handles are circular and joined at a central pivot. A small, rectangular, serrated component is shown above the jaws.	<p>Hemostatic Forceps HIC-636</p>	<p>0.00</p>
 An illustration of Hemostatic Forceps HIC-635. The instrument consists of two long, tapered jaws with serrated inner surfaces. The handles are circular and joined at a central pivot. A small, rectangular, serrated component is shown above the jaws.	<p>Hemostatic Forceps HIC-635</p>	<p>0.00</p>
 An illustration of Hemostatic Forceps HIC-634. The instrument consists of two long, tapered jaws with serrated inner surfaces. The handles are circular and joined at a central pivot. A small, curved, serrated component is shown above the jaws.	<p>Hemostatic Forceps HIC-634</p>	<p>0.00</p>
 An illustration of Hemostatic Forceps HIC-633. The instrument consists of two long, tapered jaws with serrated inner surfaces. The handles are circular and joined at a central pivot. A small, curved, serrated component is shown above the jaws.	<p>Hemostatic Forceps HIC-633</p>	<p>0.00</p>





	<p>Hemostatic Forceps HIC-632</p>	<p>0.00</p>
	<p>Hemostatic Forceps HIC-631</p>	<p>0.00</p>
	<p>Hemostatic Forceps HIC-630</p>	<p>0.00</p>
	<p>Hemostatic Forceps HIC-629</p>	<p>0.00</p>



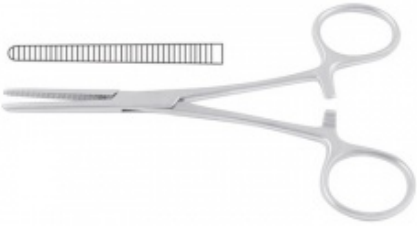

	<p>Hemostatic Forceps HIC-628</p>	<p>0.00</p>
	<p>Hemostatic Forceps HIC-627</p>	<p>0.00</p>
	<p>Hemostatic Forceps HIC-626</p>	<p>0.00</p>
	<p>Hemostatic Forceps HIC-625</p>	<p>0.00</p>





	Hemostatic Forceps HIC-624	0.00
	Hemostatic Forceps HIC-623	0.00
	Hemostatic Forceps HIC-622	0.00
	Hemostatic Forceps HIC-621	0.00

	<p>Hemostatic Forceps HIC-620</p>	<p>0.00</p>
	<p>Hemostatic Forceps HIC-619</p>	<p>0.00</p>
	<p>Hemostatic Forceps HIC-618</p>	<p>0.00</p>
	<p>Hemostatic Forceps HIC-617</p>	<p>0.00</p>

	<p>Hemostatic Forceps HIC-616</p>	<p>0.00</p>
	<p>Hemostatic Forceps HIC-615</p>	<p>0.00</p>
	<p>Hemostatic Forceps HIC-614</p>	<p>0.00</p>
	<p>Hemostatic Forceps HIC-613</p>	<p>0.00</p>



	<p>Hemostatic Forceps HIC-612</p>	<p>0.00</p>
	<p>Hemostatic Forceps HIC-611</p>	<p>0.00</p>
	<p>Hemostatic Forceps HIC-610</p>	<p>0.00</p>
	<p>Hemostatic Forceps HIC-609</p>	<p>0.00</p>

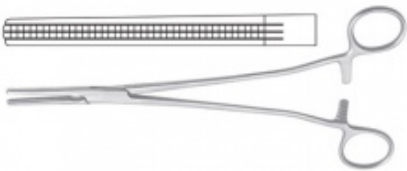
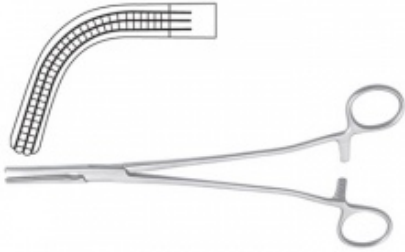
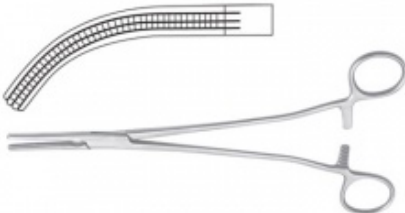

 An illustration of a pair of hemostatic forceps with long, straight jaws and serrated tips. A separate detail of the serrated tip is shown above the main illustration.	Hemostatic Forceps	0.00
 An illustration of a pair of hemostatic forceps with long, straight jaws and serrated tips. A separate detail of the serrated tip is shown above the main illustration.	Hemostatic Forceps HIC-608	0.00
 An illustration of a pair of hemostatic forceps with long, straight jaws and serrated tips. A separate detail of the serrated tip is shown above the main illustration.	Hemostatic Forceps HIC-606	0.00
 An illustration of a pair of hemostatic forceps with long, straight jaws and serrated tips. A separate detail of the serrated tip is shown above the main illustration.	Hemostatic Forceps HIC-605	0.00

	<p>Hemostatic Forceps HIC-604</p>	<p>0.00</p>
	<p>Hemostatic Forceps HIC-603</p>	<p>0.00</p>
	<p>Hemostatic Forceps HIC-602</p>	<p>0.00</p>
	<p>Hemostatic Forceps HIC-601</p>	<p>0.00</p>

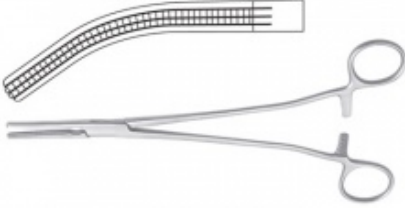
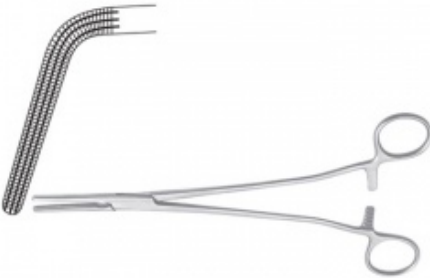



Hysterectomy Forceps

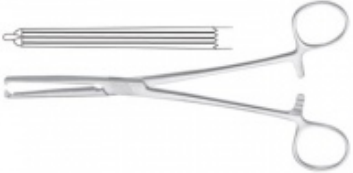

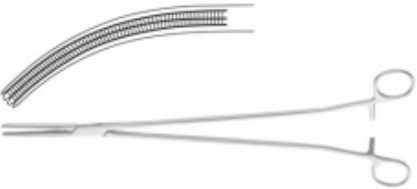
Product Image	Product Name	Price(\$)
 A pair of long-handled surgical forceps with a straight, serrated metal tip. The handles are long and have a locking mechanism.	Hysterectomy Forceps HIC-721	0.00
 A pair of long-handled surgical forceps with a curved, serrated metal tip. The handles are long and have a locking mechanism.	Hysterectomy Forceps HIC-722	0.00
 A pair of long-handled surgical forceps with a curved, serrated metal tip. The handles are long and have a locking mechanism.	Hysterectomy Forceps HIC-719	0.00



	<p>Hysterectomy Forceps HIC-720</p>	<p>0.00</p>
	<p>Hysterectomy Forceps HIC-718</p>	<p>0.00</p>
	<p>Hysterectomy Forceps HIC-717</p>	<p>0.00</p>
	<p>Hysterectomy Forceps HIC-716</p>	<p>0.00</p>

	<p>Hysterectomy Forceps HIC-715</p>	<p>0.00</p>
	<p>Hysterectomy Forceps HIC-714</p>	<p>0.00</p>
	<p>Hysterectomy Forceps HIC-713</p>	<p>0.00</p>
	<p>Hysterectomy Forceps HIC-712</p>	<p>0.00</p>

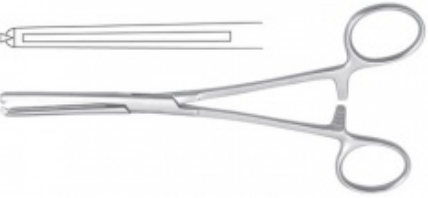

	<p>Hysterectomy Forceps HIC-711</p>	<p>0.00</p>
	<p>Hysterectomy Forceps HIC-710</p>	<p>0.00</p>
	<p>Hysterectomy Forceps HIC-709</p>	<p>0.00</p>
	<p>Hysterectomy Forceps HIC-708</p>	<p>0.00</p>

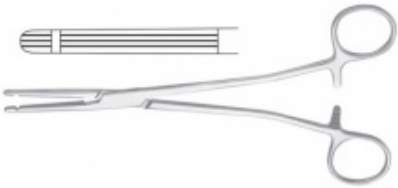
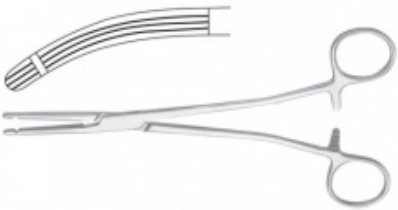
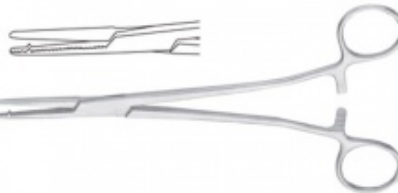
 A pair of hysterectomy forceps with long handles and curved, serrated jaws. A separate view of the curved, serrated jaw tip is shown above the main illustration.	<p>Hysterectomy Forceps HIC-707</p>	<p>0.00</p>
 A pair of hysterectomy forceps with long handles and curved, serrated jaws. A separate view of the curved, serrated jaw tip is shown above the main illustration.	<p>Hysterectomy Forceps HIC-606</p>	<p>0.00</p>
 A pair of hysterectomy forceps with long handles and curved, serrated jaws. A separate view of the curved, serrated jaw tip is shown above the main illustration.	<p>Hysterectomy Forceps HIC-705</p>	<p>0.00</p>
 A pair of hysterectomy forceps with long handles and curved, serrated jaws. A separate view of the curved, serrated jaw tip is shown above the main illustration.	<p>Hysterectomy Forceps HIC-704</p>	<p>0.00</p>

 An illustration of a pair of long-handled surgical forceps with curved jaws. A separate, curved, ribbed metal strip is shown above the forceps, representing the instrument's intended use.	<p>Hysterectomy Forceps HIC-703</p>	<p>0.00</p>
 An illustration of a pair of long-handled surgical forceps with curved jaws. A separate, curved, ribbed metal strip is shown above the forceps, representing the instrument's intended use.	<p>Hysterectomy Forceps HIC-702</p>	<p>0.00</p>
 An illustration of a pair of long-handled surgical forceps with curved jaws. A separate, curved, ribbed metal strip is shown above the forceps, representing the instrument's intended use.	<p>Hysterectomy Forceps HIC-701</p>	<p>0.00</p>
 An illustration of a pair of long-handled surgical forceps with straight jaws. A separate, straight, ribbed metal strip is shown above the forceps, representing the instrument's intended use.	<p>Hysterectomy Forceps HIC-736</p>	<p>0.00</p>

 <p>A pair of long-handled surgical forceps with circular handles and long, tapered jaws. A separate component, a long, thin, cylindrical rod with a textured grip, is shown above the forceps.</p>	<p>Hysterectomy Forceps HIC-735</p>	<p>0.00</p>
 <p>A pair of long-handled surgical forceps with circular handles and long, tapered jaws. A separate component, a curved, thin rod with a textured grip, is shown above the forceps.</p>	<p>Hysterectomy Forceps HIC-734</p>	<p>0.00</p>
 <p>A pair of long-handled surgical forceps with circular handles and long, tapered jaws. A separate component, a long, thin rod with a textured grip, is shown above the forceps.</p>	<p>Hysterectomy Forceps HIC-733</p>	<p>0.00</p>
 <p>A pair of long-handled surgical forceps with circular handles and long, tapered jaws. A separate component, a curved rod with a textured grip, is shown above the forceps.</p>	<p>Hysterectomy Forceps HIC-732</p>	<p>0.00</p>



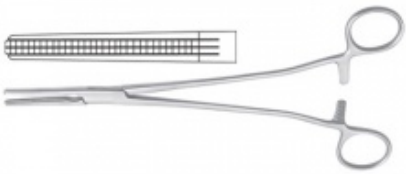
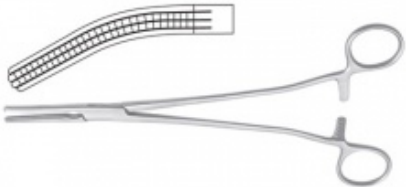

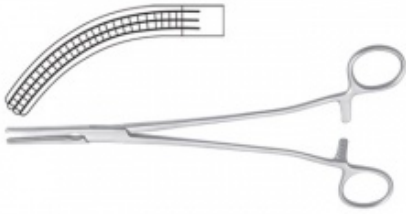
 A pair of surgical forceps with long, thin jaws and a curved, textured handle. The forceps are shown in an open position.	<p>Hysterectomy Forceps HIC-731</p>	<p>0.00</p>
 A pair of surgical forceps with long, thin jaws and a curved, textured handle. The forceps are shown in an open position.	<p>Hysterectomy Forceps HIC-730</p>	<p>0.00</p>
 A pair of surgical forceps with long, thin jaws and a curved, textured handle. The forceps are shown in an open position.	<p>Hysterectomy Forceps HIC-729</p>	<p>0.00</p>
 A pair of surgical forceps with long, thin jaws and a curved, textured handle. The forceps are shown in an open position.	<p>Hysterectomy Forceps HIC-728</p>	<p>0.00</p>

 An illustration of a pair of surgical forceps with long, curved jaws and a textured grip on the upper jaw. The handles are standard surgical forceps handles.	<p>Hysterectomy Forceps HIC-727</p>	<p>0.00</p>
 An illustration of a pair of surgical forceps with long, curved jaws and a hook-like tip on the upper jaw. The handles are standard surgical forceps handles.	<p>Hysterectomy Forceps HIC-726</p>	<p>0.00</p>
 An illustration of a pair of surgical forceps with long, straight jaws and a textured grip on the upper jaw. The handles are standard surgical forceps handles.	<p>Hysterectomy Forceps HIC-725</p>	<p>0.00</p>
 An illustration of a pair of surgical forceps with long, curved jaws and a textured grip on the upper jaw. The handles are standard surgical forceps handles.	<p>Hysterectomy Forceps HIC-724</p>	<p>0.00</p>

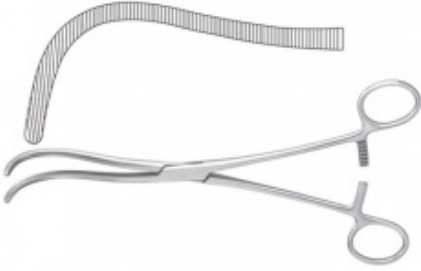
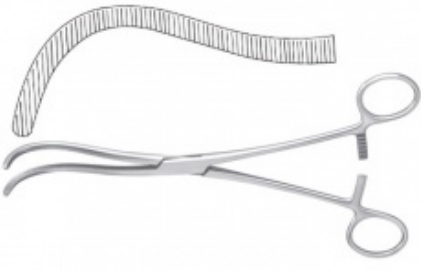
	<p>Hysterectomy Forceps HIC-723</p>	<p>0.00</p>
---	---	-------------



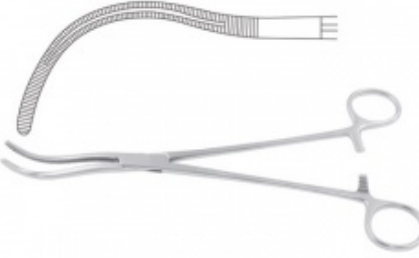

Kidney Pedicle Clamps



Product Image	Product Name	Price(\$)
	<p>Kidney Pedicle Clamps HIC-806</p>	<p>0.00</p>
	<p>Kidney Pedicle Clamps HIC-805</p>	<p>0.00</p>

	<p>Kidney Pedicle Clamps HIC-804</p>	<p>0.00</p>
	<p>Kidney Pedicle Clamps HIC-803</p>	<p>0.00</p>
	<p>Kidney Pedicle Clamps HIC-802</p>	<p>0.00</p>
	<p>Kidney Pedicle Clamps HIC-801</p>	<p>0.00</p>

Micro Vessel Clips and Nerve Approximators

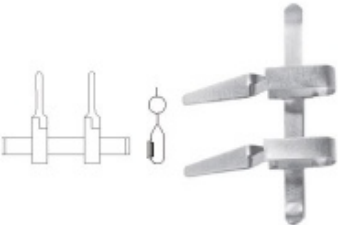

Product Image	Product Name	Price(\$)
	Micro Vessel Clips and Nerve Approximators HIC-921	0.00
	Micro Vessel Clips and Nerve Approximators HIC-920	0.00
	Micro Vessel Clips and Nerve Approximators HIC-919	0.00

	<p>Micro Vessel Clips and Nerve Approximators HIC-918</p>	<p>0.00</p>
	<p>Micro Vessel Clips and Nerve Approximators HIC-917</p>	<p>0.00</p>
	<p>Micro Vessel Clips and Nerve Approximators HIC-916</p>	<p>0.00</p>
	<p>Micro Vessel Clips and Nerve Approximators HIC-915</p>	<p>0.00</p>

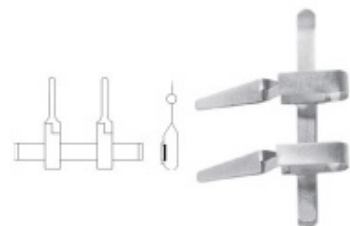
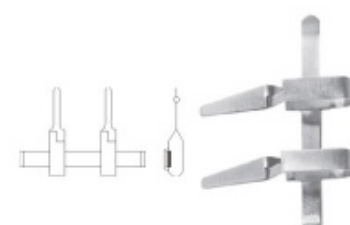
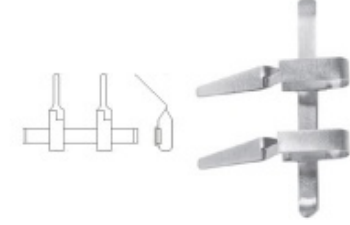
	<p>Micro Vessel Clips and Nerve Approximators HIC-914</p>	<p>0.00</p>
	<p>Micro Vessel Clips and Nerve Approximators HIC-913</p>	<p>0.00</p>
	<p>Micro Vessel Clips and Nerve Approximators HIC-912</p>	<p>0.00</p>
	<p>Micro Vessel Clips and Nerve Approximators HIC-911</p>	<p>0.00</p>



	<p>Micro Vessel Clips and Nerve Approximators HIC-910</p>	<p>0.00</p>
	<p>Micro Vessel Clips and Nerve Approximators HIC-909</p>	<p>0.00</p>
	<p>Micro Vessel Clips and Nerve Approximators HIC-908</p>	<p>0.00</p>
	<p>Micro Vessel Clips and Nerve Approximators HIC-907</p>	<p>0.00</p>

	<p>Micro Vessel Clips and Nerve Approximators HIC-906</p>	<p>0.00</p>
	<p>Micro Vessel Clips and Nerve Approximators HIC-905</p>	<p>0.00</p>
	<p>Micro Vessel Clips and Nerve Approximators HIC-904</p>	<p>0.00</p>
	<p>Micro Vessel Clips and Nerve Approximators HIC-903</p>	<p>0.00</p>

	<p>Micro Vessel Clips and Nerve Approximators HIC-902</p>	<p>0.00</p>
	<p>Micro Vessel Clips and Nerve Approximators HIC-901</p>	<p>0.00</p>

Organ Grasping Forceps



Product Image	Product Name	Price(\$)
	<p>Organ Grasping Forceps HIC-1004</p>	<p>0.00</p>

	<p>Organ Grasping Forceps HIC-1003</p>	<p>0.00</p>
	<p>Organ Grasping Forceps HIC-1002</p>	<p>0.00</p>
	<p>Organ Grasping Forceps HIC-1001</p>	<p>0.00</p>

Peritoneum Forceps

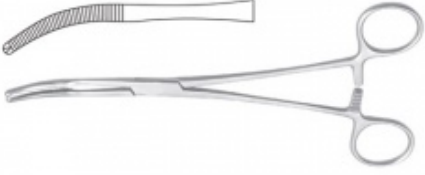
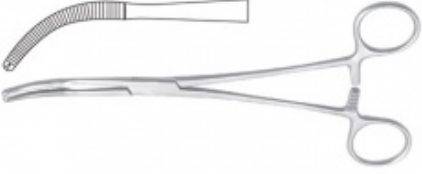
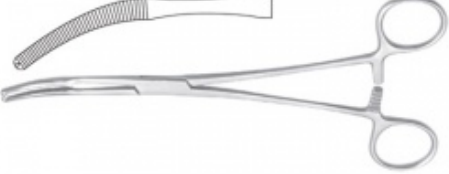

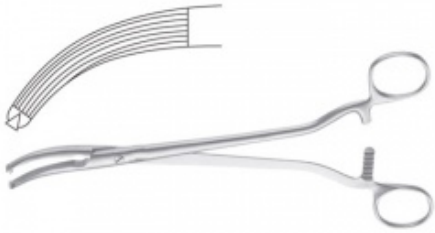
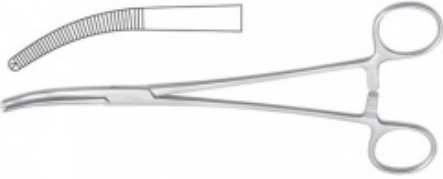

Product Image	Product Name	Price(\$)





	<p>Peritoneum Forceps HIC-1108</p>	<p>0.00</p>
	<p>Peritoneum Forceps HIC-1107</p>	<p>0.00</p>
	<p>Peritoneum Forceps HIC-1106</p>	<p>0.00</p>
	<p>Peritoneum Forceps HIC-1105</p>	<p>0.00</p>





	<p>Peritoneum Forceps HIC-1104</p>	<p>0.00</p>
	<p>Peritoneum Forceps HIC-1103</p>	<p>0.00</p>
	<p>Peritoneum Forceps HIC-1102</p>	<p>0.00</p>
	<p>Peritoneum Forceps HIC-1101</p>	<p>0.00</p>



Towel Clamps

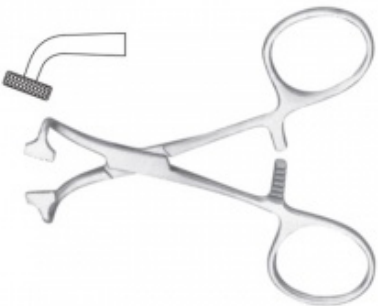

Product Image	Product Name	Price(\$)
 A silver metal towel clamp with a looped handle and a flat, rectangular clamping end.	Towel Clamps HIC-1221	0.00
 A silver metal towel clamp with a handle that has a textured grip and a flat, rectangular clamping end.	Towel Clamps HIC-1220	0.00
 A silver metal towel clamp with a handle that has a textured grip and a flat, rectangular clamping end.	Towel Clamps HIC-1219	0.00

 A metal towel clamp with a long, flat, rectangular head and a curved handle.	Towel Clamps HIC-1218	0.00
 A metal towel clamp with a curved, hook-like head and a circular handle.	Towel Clamps HIC-1217	0.00
 A metal towel clamp with a curved, hook-like head and a circular handle, similar to HIC-1217.	Towel Clamps HIC-1216	0.00
 A metal towel clamp with a curved, hook-like head and a circular handle, similar to HIC-1217 and HIC-1216.	Towel Clamps HIC-1215	0.00

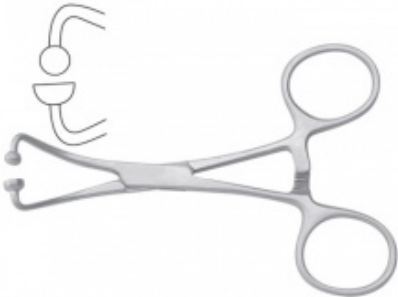
 A pair of surgical towel clamps with long, curved jaws and two circular handles.	Towel Clamps HIC-1214	0.00
 A pair of surgical towel clamps with long, curved jaws and two circular handles.	Towel Clamps HIC-1213	0.00
 A pair of surgical towel clamps with long, curved jaws and two circular handles.	Towel Clamps HIC-1212	0.00
 A pair of surgical towel clamps with long, curved jaws and two circular handles.	Towel Clamps HIC-1211	0.00





 A pair of surgical towel clamps with long handles and curved, beak-like tips.	Towel Clamps HIC-1210	0.00
 A pair of surgical towel clamps with long handles and curved, beak-like tips.	Towel Clamps HIC-1209	0.00
 A pair of surgical towel clamps with long handles, curved tips, and a locking mechanism on the handle.	Towel Clamps HIC-1208	0.00
 A pair of surgical towel clamps with long handles, curved tips, and a locking mechanism on the handle.	Towel Clamps HIC-1207	0.00





 A line drawing of a towel clamp with a long, curved handle on the left side and two circular handles on the right. The jaws are curved and have a serrated edge.	Towel Clamps HIC-1206	0.00
 A line drawing of a towel clamp with a curved handle on the left side and two circular handles on the right. The jaws are curved and have a serrated edge.	Towel Clamps HIC-1205	0.00
 A line drawing of a towel clamp with a curved handle on the left side and two circular handles on the right. The jaws are curved and have a serrated edge.	Towel Clamps HIC-1204	0.00
 A line drawing of a towel clamp with a handle on the left side that has a serrated edge, and two circular handles on the right. The jaws are curved and have a serrated edge.	Towel Clamps HIC-1203	0.00



	<p>Towel Clamps HIC-1202</p>	<p>0.00</p>
	<p>Towel Clamps HIC-1201</p>	<p>0.00</p>

Tubing Clamps

Product Image	Product Name	Price(\$)
	<p>Tubing Clamps HIC-1318</p>	<p>0.00</p>

	Tubing Clamps HIC-1317	0.00
	Tubing Clamps HIC-1316	0.00
	Tubing Clamps HIC-1315	0.00
	Tubing Clamps HIC-1314	0.00

	<p>Tubing Clamps HIC-1313</p>	<p>0.00</p>
	<p>Tubing Clamps HIC-1312</p>	<p>0.00</p>
	<p>Tubing Clamps HIC-1311</p>	<p>0.00</p>
	<p>Tubing Clamps HIC-1310</p>	<p>0.00</p>

	Tubing Clamps HIC-1309	0.00
	Tubing Clamps HIC-1308	0.00
	Tubing Clamps HIC-1307	0.00
	Tubing Clamps HIC-1306	0.00

 A metal tubing clamp with a central vertical stem that loops into a ring at the top. Two horizontal stems extend from the base of the central stem, each ending in a circular flange.	Tubing Clamps HIC-1305	0.00
 A metal tubing clamp with a central vertical stem that loops into a ring at the top. Two horizontal stems extend from the base of the central stem, each ending in a circular flange.	Tubing Clamps HIC-1304	0.00
 A metal tubing clamp with a central vertical stem that loops into a ring at the top. Two horizontal stems extend from the base of the central stem, each ending in a circular flange.	Tubing Clamps HIC-1303	0.00
 A metal tubing clamp with a central vertical stem that loops into a ring at the top. Two horizontal stems extend from the base of the central stem, each ending in a circular flange.	Tubing Clamps HIC-1302	0.00

	<p>Tubing Clamps HIC-1301</p>	<p>0.00</p>
---	-----------------------------------	-------------

DRESSING INSTRUMENTS

Oscillating Electric Saw and Accessories

Product Image	Product Name	Price(\$)
	<p>Oscillating Electric Saw and Accessories HIC-1512</p>	<p>0.00</p>
	<p>Oscillating Electric Saw and Accessories HIC-1511</p>	<p>0.00</p>

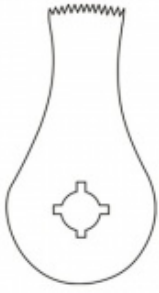
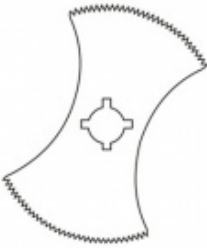



	<p>Oscillating Electric Saw and Accessories HIC-1510</p>	<p>0.00</p>
	<p>Oscillating Electric Saw and Accessories HIC-1509</p>	<p>0.00</p>
	<p>Oscillating Electric Saw and Accessories HIC-1508</p>	<p>0.00</p>
	<p>Oscillating Electric Saw and Accessories HIC-1507</p>	<p>0.00</p>

	<p>Oscillating Electric Saw and Accessories HIC-1506</p>	<p>0.00</p>
	<p>Oscillating Electric Saw and Accessories HIC-1505</p>	<p>0.00</p>
	<p>Oscillating Electric Saw and Accessories HIC-1504</p>	<p>0.00</p>
	<p>Oscillating Electric Saw and Accessories HIC-1503</p>	<p>0.00</p>

	<p>Oscillating Electric Saw and Accessories HIC-1502</p>	<p>0.00</p>
	<p>Oscillating Electric Saw and Accessories HIC-1501</p>	<p>0.00</p>

Plaster Knives and Manual Saws

Product Image	Product Name	Price(\$)
	<p>Plaster Knives and Manual Saws HIC-1605</p>	<p>0.00</p>

	<p>Plaster Knives and Manual Saws HIC-1604</p>	<p>0.00</p>
	<p>Plaster Knives and Manual Saws HIC-1603</p>	<p>0.00</p>
	<p>Plaster Knives and Manual Saws HIC-1602</p>	<p>0.00</p>
	<p>Plaster Knives and Manual Saws HIC-1601</p>	<p>0.00</p>





Plaster Shears





Product Image	Product Name	Price(\$)
	Plaster Shears HIC-1703	0.00
	Plaster Shears HIC-1702	0.00
	Plaster Shears HIC-1701	0.00





FORCEPS





Atrauma Forceps





Product Image	Product Name	Price(\$)
---------------	--------------	-----------





	Atrauma Forceps HIC-1827	0.00
	Atrauma Forceps HIC-1826	0.00
	Atrauma Forceps HIC-1825	0.00
	Atrauma Forceps HIC-1824	0.00



 Atrauma Forceps HIC-1823: A pair of blue surgical forceps with long, tapered handles and fine serrations on the jaws.	Atrauma Forceps HIC-1823	0.00
 Atrauma Forceps HIC-1822: A pair of blue surgical forceps with long, tapered handles and fine serrations on the jaws.	Atrauma Forceps HIC-1822	0.00
 Atrauma Forceps HIC-1821: A pair of blue surgical forceps with long, tapered handles and fine serrations on the jaws.	Atrauma Forceps HIC-1821	0.00
 Atrauma Forceps HIC-1820: A pair of blue surgical forceps with long, tapered handles and fine serrations on the jaws.	Atrauma Forceps HIC-1820	0.00

	Atrauma Forceps HIC-1819	0.00
	Atrauma Forceps HIC-1818	0.00
	Atrauma Forceps HIC-1817	0.00
	Atrauma Forceps HIC-1816	0.00

 Atrauma Forceps HIC-1815: A pair of surgical forceps with long, tapered handles and fine serrations on the jaws.	Atrauma Forceps HIC-1815	0.00
 Atrauma Forceps HIC-1814: A pair of surgical forceps with long, tapered handles and fine serrations on the jaws.	Atrauma Forceps HIC-1814	0.00
 Atrauma Forceps HIC-1813: A pair of surgical forceps with long, tapered handles and curved, serrated jaws.	Atrauma Forceps HIC-1813	0.00
 Atrauma Forceps HIC-1812: A pair of surgical forceps with long, tapered handles and curved, serrated jaws.	Atrauma Forceps HIC-1812	0.00





 Atrauma Forceps HIC-1811: A pair of surgical forceps with long, thin handles and curved, beak-like tips. The tips are slightly curved upwards and outwards.	Atrauma Forceps HIC-1811	0.00
 Atrauma Forceps HIC-1810: A pair of surgical forceps with long, thin handles and straight, beak-like tips. The tips are slightly curved upwards.	Atrauma Forceps HIC-1810	0.00
 Atrauma Forceps HIC-1809: A pair of surgical forceps with long, thin handles and straight, beak-like tips. The tips are slightly curved upwards.	Atrauma Forceps HIC-1809	0.00
 Atrauma Forceps HIC-1808: A pair of surgical forceps with long, thin handles and straight, beak-like tips. The tips are slightly curved upwards.	Atrauma Forceps HIC-1808	0.00

 Atrauma Forceps HIC-1807. The image shows a pair of surgical forceps with long, tapered handles and fine serrations on the inner surfaces of the jaws. A smaller inset image shows the forceps from a different perspective.	Atrauma Forceps HIC-1807	0.00
 Atrauma Forceps HIC-1806. The image shows a pair of surgical forceps with long, tapered handles and fine serrations on the inner surfaces of the jaws. A smaller inset image shows the forceps from a different perspective.	Atrauma Forceps HIC-1806	0.00
 Atrauma Forceps HIC-1805. The image shows a pair of surgical forceps with long, tapered handles and fine serrations on the inner surfaces of the jaws. A smaller inset image shows the forceps from a different perspective.	Atrauma Forceps HIC-1805	0.00
 Atrauma Forceps HIC-1804. The image shows a pair of surgical forceps with long, tapered handles and fine serrations on the inner surfaces of the jaws. A smaller inset image shows the forceps from a different perspective.	Atrauma Forceps HIC-1804	0.00



	<p>Atrauma Forceps HIC-1803</p>	<p>0.00</p>
	<p>Atrauma Forceps HIC-1802</p>	<p>0.00</p>
	<p>Atrauma Forceps HIC-1801</p>	<p>0.00</p>

Cilia Forceps

Product Image	Product Name	Price(\$)

	<p>Cilia Forceps HIC-1904</p>	<p>0.00</p>
	<p>Cilia Forceps HIC-1903</p>	<p>0.00</p>
	<p>Cilia Forceps HIC-1902</p>	<p>0.00</p>
	<p>Cilia Forceps HIC-1901</p>	<p>0.00</p>

Dissecting Forceps

Product Image	Product Name	Price(\$)
 A pair of surgical dissecting forceps, model HIC-2033. The image shows a side view of the forceps with its long, tapered handles and curved, serrated jaws. A small circular logo with the number '33' is visible in the bottom left corner of the image area.	Dissecting Forceps HIC-2033	0.00
 A pair of surgical dissecting forceps, model HIC-2032. The image shows a side view of the forceps with its long, tapered handles and curved, serrated jaws. A small circular logo with the number '32' is visible in the bottom left corner of the image area.	Dissecting Forceps HIC-2032	0.00
 A pair of surgical dissecting forceps, model HIC-2031. The image shows a side view of the forceps with its long, tapered handles and curved, serrated jaws. A small circular logo with the number '31' is visible in the bottom left corner of the image area.	Dissecting Forceps HIC-2031	0.00

 <p>③ 1.2</p>	<p>Dissecting Forceps HIC-2030</p>	<p>0.00</p>
 <p>③ 1.2</p>	<p>Dissecting Forceps HIC-2029</p>	<p>0.00</p>
 <p>③ 1.2</p>	<p>Dissecting Forceps HIC-2028</p>	<p>0.00</p>
 <p>③ 1.2</p>	<p>Dissecting Forceps HIC-2027</p>	<p>0.00</p>

 <p>③ 1/2</p>	Dissecting Forceps HIC-2026	0.00
 <p>③ 1/2</p>	Dissecting Forceps HIC-2025	0.00
 <p>③ 1/2</p>	Dissecting Forceps HIC-2024	0.00
 <p>③ 1/2</p>	Dissecting Forceps HIC-2023	0.00

 <p>③ 22</p>	<p>Dissecting Forceps HIC-2022</p>	<p>0.00</p>
 <p>③ 21</p>	<p>Dissecting Forceps HIC-2021</p>	<p>0.00</p>
 <p>③ 20</p>	<p>Dissecting Forceps HIC-2020</p>	<p>0.00</p>
 <p>③ 19</p>	<p>Dissecting Forceps HIC-2019</p>	<p>0.00</p>

 <p>③ 24</p>	<p>Dissecting Forceps HIC-2018</p>	<p>0.00</p>
 <p>③ 24</p>	<p>Dissecting Forceps HIC-2017</p>	<p>0.00</p>
 <p>③ 23</p>	<p>Dissecting Forceps HIC-2016</p>	<p>0.00</p>
 <p>③ 23</p>	<p>Dissecting Forceps HIC-2015</p>	<p>0.00</p>

 <p>⑧ 1.32</p>	<p>Dissecting Forceps HIC-2014</p>	<p>0.00</p>
 <p>⑧ 1.32</p>	<p>Dissecting Forceps HIC-2013</p>	<p>0.00</p>
 <p>⑧ 1.32</p>	<p>Dissecting Forceps HIC-2012</p>	<p>0.00</p>
 <p>⑧ 1.32</p>	<p>Dissecting Forceps HIC-2011</p>	<p>0.00</p>





 <p>③ 12</p>	<p>Dissecting Forceps HIC-2010</p>	<p>0.00</p>
 <p>③ 12</p>	<p>Dissecting Forceps HIC-2009</p>	<p>0.00</p>
 <p>③ 12</p>	<p>Dissecting Forceps HIC-2008</p>	<p>0.00</p>
 <p>③ 12</p>	<p>Dissecting Forceps HIC-2007</p>	<p>0.00</p>





 <p>③ 12</p>	Dissecting Forceps HIC-2006	0.00
 <p>③ 12</p>	Dissecting Forceps HIC-2005	0.00
 <p>③ 12</p>	Dissecting Forceps HIC-2004	0.00
 <p>③ 12</p>	Dissecting Forceps HIC-2003	0.00



	<p>Dissecting Forceps HIC-2002</p>	<p>0.00</p>
	<p>Dissecting Forceps HIC-2001</p>	<p>0.00</p>





Dressing Forceps



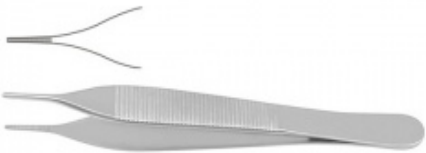

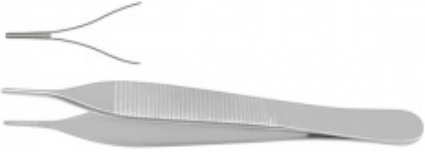
Product Image	Product Name	Price(\$)
	<p>Dressing Forceps HIC-2156</p>	<p>0.00</p>

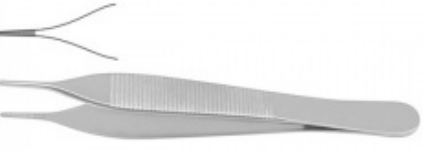
 A pair of long-handled dressing forceps with straight, pointed tips and a small hook at the top of the handle.	Dressing Forceps HIC-2155	0.00
 A pair of long-handled dressing forceps with curved tips and a small hook at the top of the handle.	Dressing Forceps HIC-2154	0.00
 A pair of long-handled dressing forceps with straight, pointed tips and a small hook at the top of the handle.	Dressing Forceps HIC-2153	0.00
 A pair of long-handled dressing forceps with straight, pointed tips and a small hook at the top of the handle.	Dressing Forceps HIC-2152	0.00





	<p>Dressing Forceps HIC-2151</p>	<p>0.00</p>
	<p>Dressing Forceps HIC-2150</p>	<p>0.00</p>
	<p>Dressing Forceps HIC-2149</p>	<p>0.00</p>
	<p>Dressing Forceps HIC-2148</p>	<p>0.00</p>

	<p>Dressing Forceps HIC-2147</p>	<p>0.00</p>
	<p>Dressing Forceps HIC-2146</p>	<p>0.00</p>
	<p>Dressing Forceps HIC-2145</p>	<p>0.00</p>
	<p>Dressing Forceps HIC-2144</p>	<p>0.00</p>





	<p>Dressing Forceps HIC-2143</p>	<p>0.00</p>
	<p>Dressing Forceps HIC-2142</p>	<p>0.00</p>
	<p>Dressing Forceps HIC-2141</p>	<p>0.00</p>
	<p>Dressing Forceps HIC-2140</p>	<p>0.00</p>





	<p>Dressing Forceps HIC-2139</p>	<p>0.00</p>
	<p>Dressing Forceps HIC-2138</p>	<p>0.00</p>
	<p>Dressing Forceps HIC-2137</p>	<p>0.00</p>
	<p>Dressing Forceps HIC-2136</p>	<p>0.00</p>





	<p>Dressing Forceps HIC-2135</p>	<p>0.00</p>
	<p>Dressing Forceps HIC-2134</p>	<p>0.00</p>
	<p>Dressing Forceps HIC-2133</p>	<p>0.00</p>
	<p>Dressing Forceps HIC-2132</p>	<p>0.00</p>





	<p>Dressing Forceps HIC-2131</p>	<p>0.00</p>
	<p>Dressing Forceps HIC-2130</p>	<p>0.00</p>
	<p>Dressing Forceps HIC-2129</p>	<p>0.00</p>
	<p>Dressing Forceps HIC-2128</p>	<p>0.00</p>





 A pair of long-handled dressing forceps with serrated tips and a textured grip on the handles.	<p>Dressing Forceps HIC-2127</p>	<p>0.00</p>
 A pair of long-handled dressing forceps with serrated tips and a textured grip on the handles.	<p>Dressing Forceps HIC-2126</p>	<p>0.00</p>
 A pair of long-handled dressing forceps with serrated tips and a textured grip on the handles.	<p>Dressing Forceps HIC-2125</p>	<p>0.00</p>
 A pair of long-handled dressing forceps with serrated tips and a textured grip on the handles.	<p>Dressing Forceps HIC-2124</p>	<p>0.00</p>



	<p>Dressing Forceps HIC-2123</p>	<p>0.00</p>
	<p>Dressing Forceps HIC-2122</p>	<p>0.00</p>
	<p>Dressing Forceps HIC-2121</p>	<p>0.00</p>
	<p>Dressing Forceps HIC-2120</p>	<p>0.00</p>

	<p>Dressing Forceps HIC-2119</p>	<p>0.00</p>
	<p>Dressing Forceps HIC-2118</p>	<p>0.00</p>
	<p>Dressing Forceps HIC-2117</p>	<p>0.00</p>
	<p>Dressing Forceps HIC-2116</p>	<p>0.00</p>



	<p>Dressing Forceps HIC-2115</p>	<p>0.00</p>
	<p>Dressing Forceps HIC-2114</p>	<p>0.00</p>
	<p>Dressing Forceps HIC-2113</p>	<p>0.00</p>
	<p>Dressing Forceps HIC-2112</p>	<p>0.00</p>





	<p>Dressing Forceps HIC-2111</p>	<p>0.00</p>
	<p>Dressing Forceps HIC-2110</p>	<p>0.00</p>
	<p>Dressing Forceps HIC-2109</p>	<p>0.00</p>
	<p>Dressing Forceps HIC-2108</p>	<p>0.00</p>





 A pair of long-handled dressing forceps with serrated tips, shown in a closed position.	<p>Dressing Forceps HIC-2107</p>	<p>0.00</p>
 A pair of long-handled dressing forceps with serrated tips, shown in a closed position.	<p>Dressing Forceps HIC-2107</p>	<p>0.00</p>
 A pair of long-handled dressing forceps with serrated tips, shown in a closed position.	<p>Dressing Forceps HIC-2106</p>	<p>0.00</p>
 A pair of long-handled dressing forceps with serrated tips, shown in a closed position.	<p>Dressing Forceps HIC-2105</p>	<p>0.00</p>

	<p>Dressing Forceps HIC-2104</p>	<p>0.00</p>
	<p>Dressing Forceps HIC-2103</p>	<p>0.00</p>
	<p>Dressing Forceps HIC-2102</p>	<p>0.00</p>
	<p>Dressing Forceps HIC-2101</p>	<p>0.00</p>

Jeweler Forceps



Product Image	Product Name	Price(\$)
 A pair of jeweler forceps with long, thin, tapered jaws and a long, straight handle.	Jeweler Forceps HIC-2212	0.00
 A pair of jeweler forceps with long, thin, tapered jaws and a long, straight handle.	Jeweler Forceps HIC-2211	0.00
 A pair of jeweler forceps with long, thin, tapered jaws and a long, straight handle.	Jeweler Forceps HIC-2210	0.00





 <p>A pair of long-handled jeweler forceps with curved tips. A small circular logo with the number '112' is visible on the left handle.</p>	<p>Jeweler Forceps HIC-2209</p>	<p>0.00</p>
 <p>A pair of long-handled jeweler forceps with curved tips.</p>	<p>Jeweler Forceps HIC-2208</p>	<p>0.00</p>
 <p>A pair of long-handled jeweler forceps with curved tips. A small rectangular component is shown above the handles.</p>	<p>Jeweler Forceps HIC-2207</p>	<p>0.00</p>
 <p>A pair of long-handled jeweler forceps with curved tips.</p>	<p>Jeweler Forceps HIC-2206</p>	<p>0.00</p>





	Jeweler Forceps HIC-2205	0.00
	Jeweler Forceps HIC-2204	0.00
	Jeweler Forceps HIC-2203	0.00
	Jeweler Forceps HIC-2202	0.00

	<p>Jeweler Forceps HIC-2201</p>	<p>0.00</p>
---	-------------------------------------	-------------

Micro Atrauma Forceps

Product Image	Product Name	Price(\$)
	<p>Micro Atrauma Forceps HIC-2312</p>	<p>0.00</p>
	<p>Micro Atrauma Forceps HIC-2311</p>	<p>0.00</p>





	Micro Atrauma Forceps HIC-2310	0.00
	Micro Atrauma Forceps HIC-2309	0.00
	Micro Atrauma Forceps HIC-2308	0.00
	Micro Atrauma Forceps HIC-2307	0.00





	Micro Atrauma Forceps HIC-2306	0.00
	Micro Atrauma Forceps HIC-2305	0.00
	Micro Atrauma Forceps HIC-2304	0.00
	Micro Atrauma Forceps HIC-2303	0.00



	<p>Micro Atrauma Forceps HIC-2302</p>	<p>0.00</p>
	<p>Micro Atrauma Forceps HIC-2301</p>	<p>0.00</p>

Micro Forceps





Product Image	Product Name	Price(\$)
	<p>Micro Forceps HIC-2330</p>	<p>0.00</p>





 A pair of micro forceps with long, thin, tapered jaws and a handle with four circular indentations.	Micro Forceps HIC-2329	0.00
 A pair of micro forceps with long, thin, tapered jaws and a handle with four circular indentations.	Micro Forceps HIC-2328	0.00
 A pair of micro forceps with long, thin, tapered jaws and a handle with four circular indentations.	Micro Forceps HIC-2327	0.00
 A pair of micro forceps with long, thin, tapered jaws and a handle with four circular indentations.	Micro Forceps HIC-2326	0.00





 A pair of micro forceps with long, thin, tapered tips and a handle with four circular indentations for grip.	Micro Forceps HIC-2325	0.00
 A pair of micro forceps with long, thin, tapered tips and a handle with four circular indentations for grip.	Micro Forceps HIC-2324	0.00
 A pair of micro forceps with long, thin, tapered tips and a handle with four circular indentations for grip.	Micro Forceps HIC-2323	0.00
 A pair of micro forceps with long, thin, tapered tips and a handle with four circular indentations for grip.	Micro Forceps HIC-2322	0.00

 A pair of micro forceps with long, thin, slightly curved tips and a handle with four circular indentations.	Micro Forceps HIC-2321	0.00
 A pair of micro forceps with long, thin, slightly curved tips and a handle with four circular indentations.	Micro Forceps HIC-2320	0.00
 A pair of micro forceps with long, thin, slightly curved tips and a handle with four circular indentations.	Micro Forceps HIC-2319	0.00
 A pair of micro forceps with long, thin, slightly curved tips and a handle with a textured grip. A circular inset shows a magnified view of the tip.	Micro Forceps HIC-2318	0.00

	<p>Micro Forceps HIC-2317</p>	<p>0.00</p>
	<p>Micro Forceps HIC-2316</p>	<p>0.00</p>
	<p>Micro Forceps HIC-2315</p>	<p>0.00</p>
	<p>Micro Forceps HIC-2314</p>	<p>0.00</p>



 A pair of long, thin micro forceps with fine serrations on the tips and a small circular logo on the handle.	Micro Forceps HIC-2313	0.00
 A pair of long, thin micro forceps with fine serrations on the tips and a small circular logo on the handle.	Micro Forceps HIC-2312	0.00
 A pair of long, thin micro forceps with fine serrations on the tips and a small circular logo on the handle.	Micro Forceps HIC-2311	0.00
 A pair of long, thin micro forceps with fine serrations on the tips and a small circular logo on the handle.	Micro Forceps HIC-2310	0.00



	<p>Micro Forceps HIC-2309</p>	<p>0.00</p>
	<p>Micro Forceps HIC-2308</p>	<p>0.00</p>
	<p>Micro Forceps HIC-2307</p>	<p>0.00</p>
	<p>HIC-2306</p>	<p>0.00</p>

 <p>A pair of long-handled micro forceps with fine serrations on the tips. A small circular inset shows a magnified view of the serrated tip.</p>	<p>Micro Forceps HIC-2305</p>	<p>0.00</p>
 <p>A pair of long-handled micro forceps with curved tips.</p>	<p>Micro Forceps HIC-2304</p>	<p>0.00</p>
 <p>A pair of long-handled micro forceps with a textured grip on the handle and curved tips.</p>	<p>Micro Forceps HIC-2303</p>	<p>0.00</p>
 <p>A pair of long-handled micro forceps with fine serrations on the tips.</p>	<p>Micro Forceps HIC-2302</p>	<p>0.00</p>



	<p>Micro Forceps HIC-2301</p>	<p>0.00</p>
---	-----------------------------------	-------------



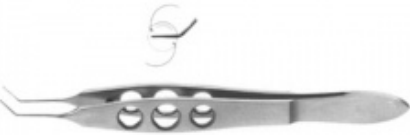

Micro Ophthalmic Forceps

Product Image	Product Name	Price(\$)
	<p>Micro Ophthalmic Forceps HIC-2430</p>	<p>0.00</p>
	<p>Micro Ophthalmic Forceps HIC-2429</p>	<p>0.00</p>



 A pair of micro ophthalmic forceps with a straight handle and a curved tip. The handle has three finger loops and a thumb loop. A small inset image shows the tip of the forceps.	<p>Micro Ophthalmic Forceps HIC-2428</p>	<p>0.00</p>
 A pair of micro ophthalmic forceps with a straight handle and a curved tip. The handle has three finger loops and a thumb loop. A small inset image shows the tip of the forceps.	<p>Micro Ophthalmic Forceps HIC-2427</p>	<p>0.00</p>
 A pair of micro ophthalmic forceps with a straight handle and a curved tip. The handle has three finger loops and a thumb loop. A small inset image shows the tip of the forceps.	<p>Micro Ophthalmic Forceps HIC-2426</p>	<p>0.00</p>
 A pair of micro ophthalmic forceps with a straight handle and a curved tip. The handle has three finger loops and a thumb loop. A small inset image shows the tip of the forceps.	<p>Micro Ophthalmic Forceps HIC-2425</p>	<p>0.00</p>





	<p>Micro Ophthalmic Forceps HIC-2424</p>	<p>0.00</p>
	<p>Micro Ophthalmic Forceps HIC-2423</p>	<p>0.00</p>
	<p>Micro Ophthalmic Forceps HIC-2422</p>	<p>0.00</p>
	<p>Micro Ophthalmic Forceps HIC-2421</p>	<p>0.00</p>

 <p>A pair of micro ophthalmic forceps with a long, straight handle and a curved, beak-like tip. The handle features three circular finger loops. A small inset image shows the tip of the forceps.</p>	<p>Micro Ophthalmic Forceps HIC-2420</p>	<p>0.00</p>
 <p>A pair of micro ophthalmic forceps with a long, straight handle and a curved, beak-like tip. The handle features three circular finger loops.</p>	<p>Micro Ophthalmic Forceps HIC-2419</p>	<p>0.00</p>
 <p>A pair of micro ophthalmic forceps with a long, straight handle and a curved, beak-like tip. The handle features three circular finger loops. A small inset image shows the tip of the forceps.</p>	<p>Micro Ophthalmic Forceps HIC-2418</p>	<p>0.00</p>
 <p>A pair of micro ophthalmic forceps with a long, straight handle and a curved, beak-like tip. The handle features three circular finger loops.</p>	<p>Micro Ophthalmic Forceps HIC-2417</p>	<p>0.00</p>



	<p>Micro Ophthalmic Forceps HIC-2416</p>	<p>0.00</p>
	<p>Micro Ophthalmic Forceps HIC-2415</p>	<p>0.00</p>
	<p>Micro Ophthalmic Forceps HIC-2414</p>	<p>0.00</p>
	<p>Micro Ophthalmic Forceps HIC-2413</p>	<p>0.00</p>





	<p>Micro Ophthalmic Forceps HIC-2412</p>	<p>0.00</p>
	<p>Micro Ophthalmic Forceps HIC-2411</p>	<p>0.00</p>
	<p>Micro Ophthalmic Forceps HIC-2410</p>	<p>0.00</p>
	<p>Micro Ophthalmic Forceps HIC-2409</p>	<p>0.00</p>





 A pair of micro ophthalmic forceps with a large, rounded handle on the left and a long, thin, slightly curved shaft on the right. The shaft has a small circular knob near the handle.	<p>Micro Ophthalmic Forceps HIC-2408</p>	<p>0.00</p>
 A pair of micro ophthalmic forceps with a circular handle on the left and a long, thin shaft on the right. The shaft has a textured grip section and a small circular knob near the handle.	<p>Micro Ophthalmic Forceps HIC-2407</p>	<p>0.00</p>
 A pair of micro ophthalmic forceps with a circular handle on the left and a long, thin shaft on the right. The shaft has a textured grip section and a small circular knob near the handle.	<p>Micro Ophthalmic Forceps HIC-2406</p>	<p>0.00</p>
 A pair of micro ophthalmic forceps with a circular handle on the left and a long, thin shaft on the right. The shaft has a textured grip section and a small circular knob near the handle.	<p>Micro Ophthalmic Forceps HIC-2405</p>	<p>0.00</p>

	<p>Micro Ophthalmic Forceps HIC-2404</p>	<p>0.00</p>
	<p>Micro Ophthalmic Forceps HIC-2403</p>	<p>0.00</p>
	<p>Micro Ophthalmic Forceps HIC-2402</p>	<p>0.00</p>
	<p>Micro Ophthalmic Forceps HIC-2401</p>	<p>0.00</p>





Micro Suturing Forceps





Product Image	Product Name	Price(\$)
 The image shows two pairs of micro suturing forceps. The top pair is a long, thin pair with a small circular logo on the upper handle. The bottom pair is a shorter, thicker pair with a similar circular logo on the upper handle.	Micro Suturing Forceps HIC-2527	0.00
 The image shows a pair of micro suturing forceps with a long handle and a curved tip. There are three circular logos on the handle. A small circular logo with the number '12' is visible in the bottom left corner of the image area.	Micro Suturing Forceps HIC-2526	0.00
 The image shows a pair of micro suturing forceps with a long handle and a curved tip. There are three circular logos on the handle. A small circular logo with the number '12' is visible in the bottom left corner of the image area.	Micro Suturing Forceps HIC-2525	0.00



 <p>The image shows a pair of micro suturing forceps, model HIC-2524. The forceps have long, thin, tapered jaws with fine serrations. The handle is long and features three circular finger loops. A small inset image shows the tip of the forceps. A circular icon with a cross and the number '12' is located in the bottom left corner of the image area.</p>	<p>Micro Suturing Forceps HIC-2524</p>	<p>0.00</p>
 <p>The image shows a pair of micro suturing forceps, model HIC-2523. The forceps have long, thin, tapered jaws with fine serrations. The handle is long and features three circular finger loops. A small inset image shows the tip of the forceps. A circular icon with a cross and the number '12' is located in the bottom left corner of the image area.</p>	<p>Micro Suturing Forceps HIC-2523</p>	<p>0.00</p>
 <p>The image shows a pair of micro suturing forceps, model HIC-2522. The forceps have long, thin, tapered jaws with fine serrations. The handle is long and features three circular finger loops. A small inset image shows the tip of the forceps. A circular icon with a cross and the number '12' is located in the bottom left corner of the image area.</p>	<p>Micro Suturing Forceps HIC-2522</p>	<p>0.00</p>
 <p>The image shows a pair of micro suturing forceps, model HIC-2521. The forceps have long, thin, tapered jaws with fine serrations. The handle is long and features three circular finger loops. A small inset image shows the tip of the forceps. A circular icon with a cross and the number '12' is located in the bottom left corner of the image area.</p>	<p>Micro Suturing Forceps HIC-2521</p>	<p>0.00</p>

 <p>A pair of micro suturing forceps with long, thin, curved tips and three finger loops. A small icon of the forceps is shown in the top left corner, and a circled '3' with '12' is in the bottom left corner.</p>	<p>Micro Suturing Forceps HIC-2520</p>	<p>0.00</p>
 <p>A pair of micro suturing forceps with long, thin, curved tips and three finger loops. A small icon of the forceps is shown in the top left corner, and a circled '3' with '12' is in the bottom left corner.</p>	<p>Micro Suturing Forceps HIC-2519</p>	<p>0.00</p>
 <p>A pair of micro suturing forceps with long, thin, straight tips and three finger loops. A small icon of the forceps is shown in the top left corner.</p>	<p>Micro Suturing Forceps HIC-2518</p>	<p>0.00</p>
 <p>A pair of micro suturing forceps with long, thin, curved tips and three finger loops. A small icon of the forceps is shown in the top left corner.</p>	<p>Micro Suturing Forceps HIC-2517</p>	<p>0.00</p>

	<p>Micro Suturing Forceps HIC-2516</p>	<p>0.00</p>
	<p>Micro Suturing Forceps HIC-2515</p>	<p>0.00</p>
	<p>Micro Suturing Forceps HIC-2514</p>	<p>0.00</p>
	<p>Micro Suturing Forceps HIC-2513</p>	<p>0.00</p>





 A pair of micro suturing forceps with long, thin, tapered jaws and a handle with three circular finger loops. A small inset image shows the forceps with a suture thread.	<p>Micro Suturing Forceps HIC-2512</p>	<p>0.00</p>
 A pair of micro suturing forceps with long, thin, tapered jaws and a handle with a textured grip and a circular finger loop. A small inset image shows the forceps with a suture thread.	<p>Micro Suturing Forceps HIC-2511</p>	<p>0.00</p>
 A pair of micro suturing forceps with long, thin, tapered jaws and a handle with a textured grip and a circular finger loop. A small inset image shows the forceps with a suture thread.	<p>Micro Suturing Forceps HIC-2510</p>	<p>0.00</p>
 A pair of micro suturing forceps with long, thin, tapered jaws and a handle with a textured grip and a circular finger loop. A small inset image shows the forceps with a suture thread.	<p>Micro Suturing Forceps HIC-2509</p>	<p>0.00</p>





	<p>Micro Suturing Forceps HIC-2508</p>	<p>0.00</p>
	<p>Micro Suturing Forceps HIC-2507</p>	<p>0.00</p>
	<p>Micro Suturing Forceps HIC-2506</p>	<p>0.00</p>
	<p>Micro Suturing Forceps HIC-2505</p>	<p>0.00</p>



	<p>Micro Suturing Forceps HIC-2504</p>	<p>0.00</p>
	<p>Micro Suturing Forceps HIC-2503</p>	<p>0.00</p>
	<p>Micro Suturing Forceps HIC-2502</p>	<p>0.00</p>
	<p>Micro Suturing Forceps HIC-2501</p>	<p>0.00</p>

Splinter Forceps

Product Image	Product Name	Price(\$)
 A pair of surgical splinter forceps with long, tapered handles and curved, pointed tips. The handles have a textured grip.	Splinter Forceps HIC-2618	0.00
 A pair of surgical splinter forceps with long, tapered handles and curved, pointed tips. The handles have a textured grip.	Splinter Forceps HIC-2617	0.00
 A pair of surgical splinter forceps with long, tapered handles and curved, pointed tips. The handles have a textured grip.	Splinter Forceps HIC-2616	0.00

	<p>Splinter Forceps HIC-2615</p>	<p>0.00</p>
	<p>Splinter Forceps HIC-2614</p>	<p>0.00</p>
	<p>Splinter Forceps HIC-2613</p>	<p>0.00</p>
	<p>Splinter Forceps HIC-2612</p>	<p>0.00</p>



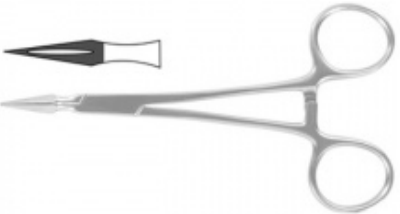
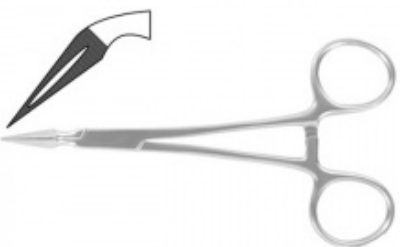

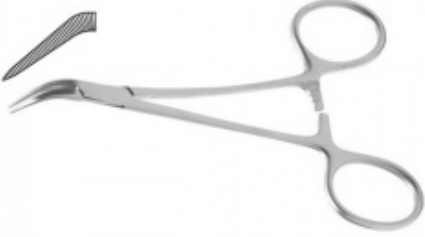
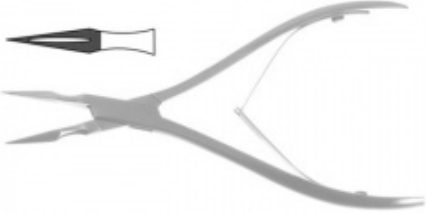
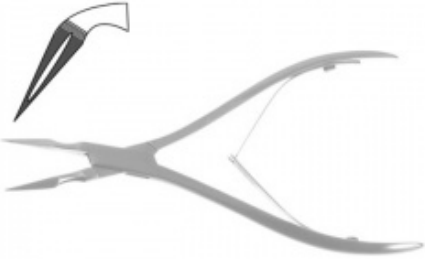
	<p>Splinter Forceps HIC-2611</p>	<p>0.00</p>
	<p>Splinter Forceps HIC-2610</p>	<p>0.00</p>
	<p>Splinter Forceps HIC-2609</p>	<p>0.00</p>
	<p>Splinter Forceps HIC-2608</p>	<p>0.00</p>



 A pair of long-handled surgical forceps with a serrated inner surface on the jaws and a small hook at the tip.	<p>Splinter Forceps HIC-2607</p>	<p>0.00</p>
 A pair of long-handled surgical forceps with a circular ring at the base of the handles and a hook at the tip.	<p>Splinter Forceps HIC-2606</p>	<p>0.00</p>
 A pair of long-handled surgical forceps with a hook at the tip and a small notch on the handle.	<p>Splinter Forceps HIC-2605</p>	<p>0.00</p>
 A pair of long-handled surgical forceps with a hook at the tip and a small notch on the handle.	<p>Splinter Forceps HIC-2604</p>	<p>0.00</p>



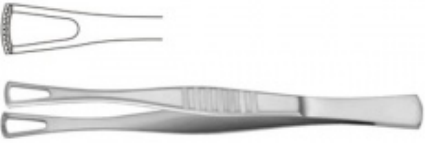

	<p>Splinter Forceps HIC-2603</p>	<p>0.00</p>
	<p>Splinter Forceps HIC-2602</p>	<p>0.00</p>
	<p>Splinter Forceps HIC-2601</p>	<p>0.00</p>

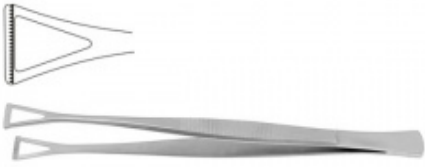
Tissue Grasping Forceps

Product Image	Product Name	Price(\$)
	<p>Placeholder for Product Name</p>	<p>Placeholder for Price(\$)</p>

	<p>Tissue Grasping Forceps HIC-2719</p>	<p>0.00</p>
	<p>Tissue Grasping Forceps HIC-2718</p>	<p>0.00</p>
	<p>Tissue Grasping Forceps HIC-2717</p>	<p>0.00</p>
	<p>Tissue Grasping Forceps HIC-2716</p>	<p>0.00</p>

	<p>Tissue Grasping Forceps HIC-2715</p>	<p>0.00</p>
	<p>Tissue Grasping Forceps HIC-2714</p>	<p>0.00</p>
	<p>Tissue Grasping Forceps HIC-2713</p>	<p>0.00</p>
	<p>Tissue Grasping Forceps HIC-2712</p>	<p>0.00</p>





	Tissue Grasping Forceps HIC-2711	0.00
	Tissue Grasping Forceps HIC-2710	0.00
	Tissue Grasping Forceps HIC-2709	0.00
	Tissue Grasping Forceps HIC-2708	0.00





 <p>A 3D rendering of a pair of tissue grasping forceps. The instrument consists of two long, tapered handles that meet at a point. The distal ends of the handles are curved and pointed, forming a beak-like shape. The handles have a textured surface for grip. A small, circular detail of the handle's end is shown separately to the left.</p>	<p>Tissue Grasping Forceps HIC-2706</p>	<p>0.00</p>
 <p>A 3D rendering of a pair of tissue grasping forceps. The instrument consists of two long, tapered handles that meet at a point. The distal ends of the handles are curved and pointed, forming a beak-like shape. The handles have a textured surface for grip. A small, circular detail of the handle's end is shown separately to the left.</p>	<p>Tissue Grasping Forceps HIC-2705</p>	<p>0.00</p>
 <p>A 3D rendering of a pair of tissue grasping forceps. The instrument consists of two long, tapered handles that meet at a point. The distal ends of the handles are curved and pointed, forming a beak-like shape. The handles have a textured surface for grip. A small, circular detail of the handle's end is shown separately to the left.</p>	<p>Tissue Grasping Forceps HIC-2704</p>	<p>0.00</p>
 <p>A 3D rendering of a pair of tissue grasping forceps. The instrument consists of two long, tapered handles that meet at a point. The distal ends of the handles are curved and pointed, forming a beak-like shape. The handles have a textured surface for grip. A small, circular detail of the handle's end is shown separately to the left.</p>	<p>Tissue Grasping Forceps HIC-2703</p>	<p>0.00</p>

	<p>Tissue Grasping Forceps HIC-2702</p>	<p>0.00</p>
	<p>Tissue Grasping Forceps HIC-2701</p>	<p>0.00</p>



Tumor Grasping Forceps





Product Image	Product Name	Price(\$)
	<p>Tumor Grasping Forceps HIC-2809</p>	<p>0.00</p>





	<p>Tumor Grasping Forceps HIC-2808</p>	<p>0.00</p>
	<p>Tumor Grasping Forceps HIC-2807</p>	<p>0.00</p>
	<p>Tumor Grasping Forceps HIC-2806</p>	<p>0.00</p>
	<p>Tumor Grasping Forceps HIC-2805</p>	<p>0.00</p>





	<p>Tumor Grasping Forceps HIC-2804</p>	<p>0.00</p>
	<p>Tumor Grasping Forceps HIC-2803</p>	<p>0.00</p>
	<p>Tumor Grasping Forceps HIC-2802</p>	<p>0.00</p>
	<p>Tumor Grasping Forceps HIC-2801</p>	<p>0.00</p>



Tungsten Carbide Forceps

Product Image	Product Name	Price(\$)
	Tungsten Carbide Forceps HIC-2918	0.00
	Tungsten Carbide Forceps HIC-2917	0.00
	Tungsten Carbide Forceps HIC-2916	0.00

	<p>Tungsten Carbide Forceps HIC-2915</p>	<p>0.00</p>
	<p>Tungsten Carbide Forceps HIC-2914</p>	<p>0.00</p>
	<p>Tungsten Carbide Forceps HIC-2913</p>	<p>0.00</p>
	<p>Tungsten Carbide Forceps HIC-2912</p>	<p>0.00</p>

 <p>The image shows a pair of tungsten carbide forceps with a yellow handle and a silver-colored metal shaft. The tips are finely serrated. A small inset image shows the tip detail, and a circled '1:2' magnification symbol is present below the main image.</p>	<p>Tungsten Carbide Forceps HIC-2911</p>	<p>0.00</p>
 <p>The image shows a pair of tungsten carbide forceps with a yellow handle and a silver-colored metal shaft. The tips are finely serrated. A small inset image shows the tip detail, and a circled '1:2' magnification symbol is present below the main image.</p>	<p>Tungsten Carbide Forceps HIC-2910</p>	<p>0.00</p>
 <p>The image shows a pair of tungsten carbide forceps with a yellow handle and a silver-colored metal shaft. The tips are finely serrated. A small inset image shows the tip detail.</p>	<p>Tungsten Carbide Forceps HIC-2909</p>	<p>0.00</p>
 <p>The image shows a pair of tungsten carbide forceps with a yellow handle and a silver-colored metal shaft. The tips are finely serrated. A small inset image shows the tip detail.</p>	<p>Tungsten Carbide Forceps HIC-2908</p>	<p>0.00</p>





 <p>A pair of tungsten carbide forceps with a yellow handle and a textured grip. The tips are pointed and slightly curved. A small inset image shows the tip of the forceps.</p>	<p>Tungsten Carbide Forceps HIC-2907</p>	<p>0.00</p>
 <p>A pair of tungsten carbide forceps with a yellow handle and a textured grip. The tips are pointed and slightly curved. A small inset image shows the tip of the forceps.</p>	<p>Tungsten Carbide Forceps HIC-2906</p>	<p>0.00</p>
 <p>A pair of tungsten carbide forceps with a yellow handle and a textured grip. The tips are pointed and slightly curved. A small inset image shows the tip of the forceps.</p>	<p>Tungsten Carbide Forceps HIC-2905</p>	<p>0.00</p>
 <p>A pair of tungsten carbide forceps with a yellow handle and a textured grip. The tips are pointed and slightly curved. A small inset image shows the tip of the forceps.</p>	<p>Tungsten Carbide Forceps HIC-2904</p>	<p>0.00</p>





	<p>Tungsten Carbide Forceps HIC-2903</p>	<p>0.00</p>
	<p>Tungsten Carbide Forceps HIC-2902</p>	<p>0.00</p>
	<p>Tungsten Carbide Forceps HIC-2901</p>	<p>0.00</p>

PROBES, COTTON APPLICATORS AND SPATULAS

Cotton Applicators



Product Image	Product Name	Price(\$)





	Cotton Applicators HIC-3109	0.00
	Cotton Applicators HIC-3108	0.00
	Cotton Applicators HIC-3107	0.00
	Cotton Applicators HIC-3106	0.00

	Cotton Applicators HIC-3105	0.00
	Cotton Applicators HIC-3104	0.00
	Cotton Applicators HIC-3103	0.00
	Cotton Applicators HIC-3102	0.00

	<p>Cotton Applicators HIC-3101</p>	<p>0.00</p>
---	--	-------------



Fistula Probes

Product Image	Product Name	Price(\$)
	<p>Fistula Probes HIC-3207</p>	<p>0.00</p>
	<p>Fistula Probes HIC-3206</p>	<p>0.00</p>

 A long, thin, cylindrical metal probe with a hook-like tip and a handle with a textured grip.	Fistula Probes HIC-3205	0.00
 A long, thin, cylindrical metal probe with a curved tip and a handle with a textured grip.	Fistula Probes HIC-3204	0.00
 A long, thin, cylindrical metal probe with a curved tip and a handle with a textured grip.	Fistula Probes HIC-3203	0.00
 A long, thin, cylindrical metal probe with a curved tip and a handle with a textured grip.	Fistula Probes HIC-3202	0.00

	<p>Fistula Probes HIC-3201</p>	<p>0.00</p>
---	------------------------------------	-------------

Probes and Directors

Product Image	Product Name	Price(\$)
	<p>Probes and Directors HIC-3315</p>	<p>0.00</p>
	<p>Probes and Directors HIC-3314</p>	<p>0.00</p>

<hr/>	Probes and Directors HIC-3313	0.00
<hr/>	Probes and Directors HIC-3312	0.00
<hr/>	Probes and Directors HIC-3311	0.00
<hr/>	Probes and Directors HIC-3310	0.00





<hr/>	Probes and Directors HIC-3309	0.00
<hr/>	Probes and Directors HIC-3308	0.00
<hr/>	Probes and Directors HIC-3307	0.00
<hr/>	Probes and Directors HIC-3306	0.00

<hr/>	Probes and Directors HIC-3305	0.00
<hr/>	Probes and Directors HIC-3304	0.00
<hr/>	Probes and Directors HIC-3303	0.00
<hr/>	Probes and Directors HIC-3302	0.00

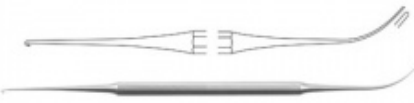
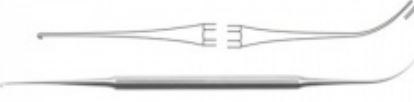

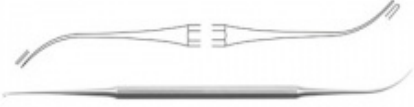
	<p>Probes and Directors HIC-3301</p>	<p>0.00</p>
---	--	-------------





Varices Instruments

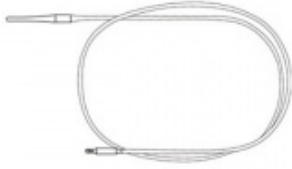
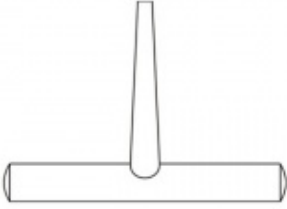

Product Image	Product Name	Price(\$)
	<p>Varices Instruments HIC-3306</p>	<p>0.00</p>
	<p>Varices Instruments HIC-3305</p>	<p>0.00</p>

	<p>Varices Instruments HIC-3304</p>	<p>0.00</p>
	<p>Varices Instruments HIC-3403</p>	<p>0.00</p>
	<p>Varices Instruments HIC-3402</p>	<p>0.00</p>
	<p>Varices Instruments HIC-3401</p>	<p>0.00</p>

Vein Probes





Product Image	Product Name	Price(\$)
	Vein Probes HIC-3509	0.00
	Vein Probes HIC-3508	0.00
	Vein Probes HIC-3507	0.00





	Vein Probes HIC-3506	0.00
	Vein Probes HIC-3505	0.00
	Vein Probes HIC-3504	0.00
	Vein Probes HIC-3503	0.00

	<p>Vein Probes HIC-3502</p>	<p>0.00</p>
	<p>Vein Probes HIC-3501</p>	<p>0.00</p>

Vein Strippers



Product Image	Product Name	Price(\$)
	<p>Vein Strippers HIC-3609</p>	<p>0.00</p>





 A pair of vein strippers with a long, straight handle and a small circular head.	Vein Strippers HIC-3608	0.00
 A pair of vein strippers with a long, straight handle and a small circular head.	Vein Strippers HIC-3607	0.00
 A pair of vein strippers with a long, straight handle and a small circular head.	Vein Strippers HIC-3606	0.00
 A pair of vein strippers with a long, straight handle and a small circular head.	Vein Strippers HIC-3605	0.00



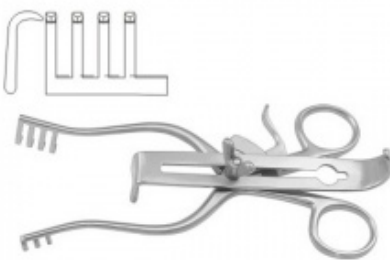

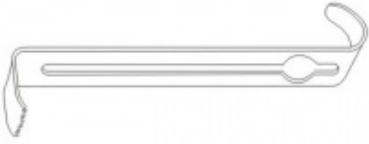
	Vein Strippers HIC-3604	0.00
	Vein Strippers HIC-3603	0.00
	Vein Strippers HIC-3602	0.00
	Vein Strippers HIC-3601	0.00

RETRACTORS

Abdominal Retractors

Product Image	Product Name	Price(\$)
 The image shows two components of the HIC-4141 abdominal retractor. The top component is a thin, L-shaped metal rod with a threaded end. The bottom component is a curved, metallic, bowl-shaped base with a central opening and a threaded hole on its side.	Abdominal Retractors HIC-4141	0.00
 The image shows two components of the HIC-4140 abdominal retractor. The top component is a curved metal rod with a threaded end. The bottom component is a curved, metallic, bowl-shaped base with a central opening and a threaded hole on its side.	Abdominal Retractors HIC-4140	0.00
 The image shows two components of the HIC-4139 abdominal retractor. The top component is a metal rod with four vertical prongs. The bottom component is a pair of surgical forceps with long, curved handles and serrated jaws.	Abdominal Retractors HIC-4139	0.00





	<p>Abdominal Retractors HIC-4138</p>	<p>0.00</p>
	<p>Abdominal Retractors HIC-4137</p>	<p>0.00</p>
	<p>Abdominal Retractors HIC-4136</p>	<p>0.00</p>
	<p>Abdominal Retractors HIC-4135</p>	<p>0.00</p>

	<p>Abdominal Retractors HIC-4134</p>	<p>0.00</p>
	<p>Abdominal Retractors HIC-4133</p>	<p>0.00</p>
	<p>Abdominal Retractors HIC-4132</p>	<p>0.00</p>
	<p>Abdominal Retractors HIC-4131</p>	<p>0.00</p>

 A metal abdominal retractor with two large, curved, adjustable arms on either side of a central vertical post. The arms are connected to a horizontal bar that can slide up and down the post. The central post has a hook at the top and a handle at the bottom.	<p>Abdominal Retractors HIC-4130</p>	<p>0.00</p>
 A metal abdominal retractor with a single large, curved, adjustable arm on the left side of a central vertical post. The arm is connected to a horizontal bar that can slide up and down the post. The central post has a hook at the top and a handle at the bottom.	<p>Abdominal Retractors HIC-4129</p>	<p>0.00</p>
 A metal abdominal retractor with a single large, curved, adjustable arm on the left side of a central vertical post. The arm is connected to a horizontal bar that can slide up and down the post. The central post has a hook at the top and a handle at the bottom.	<p>Abdominal Retractors HIC-4128</p>	<p>0.00</p>
 A metal abdominal retractor with two large, curved, adjustable arms on either side of a central vertical post. The arms are connected to a horizontal bar that can slide up and down the post. The central post has a hook at the top and a handle at the bottom.	<p>Abdominal Retractors HIC-4127</p>	<p>0.00</p>

	<p>Abdominal Retractors HIC-4126</p>	<p>0.00</p>
	<p>Abdominal Retractors HIC-4125</p>	<p>0.00</p>
	<p>Abdominal Retractors HIC-4124</p>	<p>0.00</p>
	<p>Abdominal Retractors HIC-4123</p>	<p>0.00</p>

	<p>Abdominal Retractors HIC-4122</p>	<p>0.00</p>
	<p>Abdominal Retractors HIC-4121</p>	<p>0.00</p>
	<p>Abdominal Retractors HIC-4120</p>	<p>0.00</p>
	<p>Abdominal Retractors HIC-4119</p>	<p>0.00</p>

	<p>Abdominal Retractors HIC-4118</p>	<p>0.00</p>
	<p>Abdominal Retractors HIC-4117</p>	<p>0.00</p>
	<p>Abdominal Retractors HIC-4116</p>	<p>0.00</p>
	<p>Abdominal Retractors HIC-4115</p>	<p>0.00</p>

	<p>Abdominal Retractors HIC-4114</p>	<p>0.00</p>
	<p>Abdominal Retractors HIC-4113</p>	<p>0.00</p>
	<p>Abdominal Retractors HIC-4112</p>	<p>0.00</p>
	<p>Abdominal Retractors HIC-411</p>	<p>0.00</p>

 A grey, L-shaped abdominal retractor with a curved top edge and a small circular knob at the end of the horizontal arm.	<p>Abdominal Retractors HIC-4110</p>	<p>0.00</p>
 A grey, L-shaped abdominal retractor with a curved top edge and a small circular knob at the end of the horizontal arm.	<p>Abdominal Retractors HIC-4109</p>	<p>0.00</p>
 A grey, L-shaped abdominal retractor with a straight top edge and a small circular knob at the end of the horizontal arm.	<p>Abdominal Retractors HIC-4108</p>	<p>0.00</p>
 A grey, L-shaped abdominal retractor with a straight top edge and a small circular knob at the end of the horizontal arm.	<p>Abdominal Retractors HIC-4107</p>	<p>0.00</p>

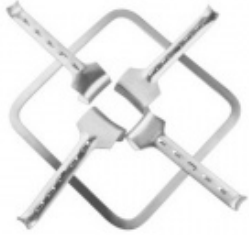
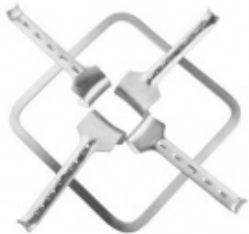
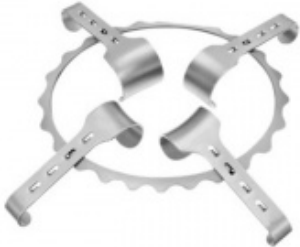
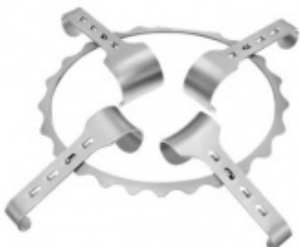
	<p>Abdominal Retractors HIC-4106</p>	<p>0.00</p>
	<p>Abdominal Retractors HIC-4105</p>	<p>0.00</p>
	<p>Abdominal Retractors HIC-4104</p>	<p>0.00</p>
	<p>Abdominal Retractors HIC-4103</p>	<p>0.00</p>

	<p>Abdominal Retractors HIC-4102</p>	<p>0.00</p>
	<p>Abdominal Retractors HIC-4101</p>	<p>0.00</p>



Abdominal Spatulas



Product Image	Product Name	Price(\$)
	<p>Abdominal Spatulas HIC-4221</p>	<p>0.00</p>

	Abdominal Spatulas HIC-4220	0.00
	Abdominal Spatulas HIC-4219	0.00
	Abdominal Spatulas HIC-4218	0.00
	Abdominal Spatulas HIC-4217	0.00

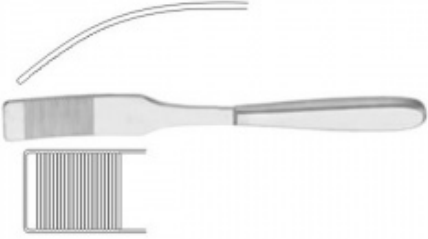
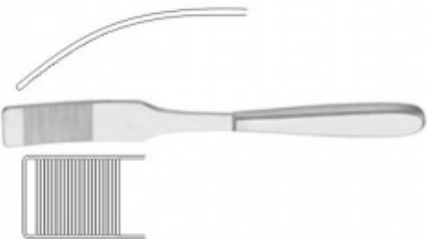
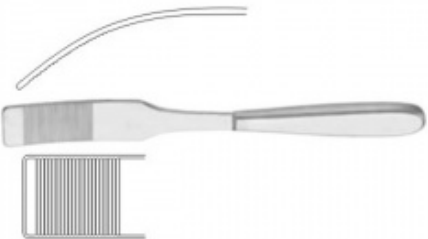

	Abdominal Spatulas HIC-4216	0.00
	Abdominal Spatulas HIC-4215	0.00
	Abdominal Spatulas HIC-4214	0.00
	Abdominal Spatulas HIC-4213	0.00

	Abdominal Spatulas HIC-4212	0.00
	Abdominal Spatulas HIC-4211	0.00
	Abdominal Spatulas HIC-4210	0.00
	Abdominal Spatulas HIC-4209	0.00

 An illustration of an abdominal spatula with a long, thin metal blade and a curved handle.	Abdominal Spatulas HIC-4208	0.00
 An illustration of an abdominal spatula with a long, thin metal blade and a curved handle.	Abdominal Spatulas HIC-4207	0.00
 An illustration of an abdominal spatula with a long, thin metal blade and a curved handle.	Abdominal Spatulas HIC-4206	0.00
 An illustration of an abdominal spatula with a long, thin metal blade and a curved handle.	Abdominal Spatulas HIC-4205	0.00

	<p>Abdominal Spatulas HIC-4204</p>	<p>0.00</p>
	<p>Abdominal Spatulas HIC-4203</p>	<p>0.00</p>
	<p>Abdominal Spatulas HIC-4202</p>	<p>0.00</p>
	<p>Abdominal Spatulas HIC-4201</p>	<p>0.00</p>



Bladder Retractors

Product Image	Product Name	Price(\$)
 A silver metal bladder retractor with two curved arms and a central handle. Two small rectangular components are shown above the main device.	Bladder Retractors HIC-4308	0.00
 A silver metal bladder retractor with two curved arms and a central handle.	Bladder Retractors HIC-4307	0.00
 A silver metal bladder retractor with two curved arms and a central handle.	Bladder Retractors HIC-4306	0.00



 A small, metallic, C-shaped retractor with a central screw.	Bladder Retractors HIC-4305	0.00
 A small, metallic, C-shaped retractor with a central screw.	Bladder Retractors HIC-4304	0.00
 A long, thin, curved metallic retractor.	Bladder Retractors HIC-4303	0.00
 A complex, multi-armed metallic retractor.	Bladder Retractors HIC-4302	0.00

	<p>Bladder Retractors HIC-4301</p>	<p>0.00</p>
---	--	-------------

Cardiovascular Retractors

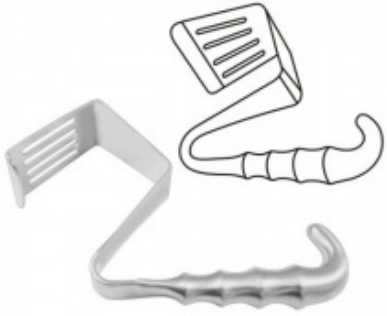



Product Image	Product Name	Price(\$)
	<p>Cardiovascular Retractors HIC-4409</p>	<p>0.00</p>
	<p>Cardiovascular Retractors HIC-4408</p>	<p>0.00</p>





	<p>Cardiovascular Retractors HIC-4407</p>	<p>0.00</p>
	<p>Cardiovascular Retractors HIC-4406</p>	<p>0.00</p>
	<p>Cardiovascular Retractors HIC-4405</p>	<p>0.00</p>
	<p>Cardiovascular Retractors HIC-4404</p>	<p>0.00</p>





	<p>Cardiovascular Retractors HIC-4403</p>	<p>0.00</p>
	<p>Cardiovascular Retractors HIC-4402</p>	<p>0.00</p>
	<p>Cardiovascular Retractors HIC-4401</p>	<p>0.00</p>



Delicate Hooks

Product Image	Product Name	Price(\$)

	<p>Delicate Hooks HIC-4515</p>	<p>0.00</p>
	<p>Delicate Hooks HIC-4514</p>	<p>0.00</p>
	<p>Delicate Hooks HIC-4513</p>	<p>0.00</p>
	<p>Delicate Hooks HIC-4512</p>	<p>0.00</p>





 A dental hook instrument with a curved tip and a textured handle.	Delicate Hooks HIC-4511	0.00
 A dental hook instrument with a curved tip and a textured handle.	Delicate Hooks HIC-4510	0.00
 A dental hook instrument with a curved tip and a textured handle.	Delicate Hooks HIC-4509	0.00
 A dental hook instrument with a curved tip and a textured handle.	Delicate Hooks HIC-4508	0.00

 A long, thin surgical hook with a curved tip and a textured handle.	Delicate Hooks HIC-4507	0.00
 A long, thin surgical hook with a curved tip and a textured handle.	Delicate Hooks HIC-4506	0.00
 A long, thin surgical hook with a curved tip and a textured handle.	Delicate Hooks HIC-4505	0.00
 A long, thin surgical hook with a curved tip and a textured handle.	Delicate Hooks HIC-4504	0.00

	<p>Delicate Hooks HIC-4503</p>	<p>0.00</p>
	<p>Delicate Hooks HIC-4502</p>	<p>0.00</p>
	<p>Delicate Hooks HIC-4501</p>	<p>0.00</p>





General Retractors





Product Image	Product Name	Price(\$)

 A surgical retractor with a long, thin shaft, a hook at the tip, and a ring handle.	<p>General Retractors HIC-4645</p>	<p>0.00</p>
 A surgical retractor with a long, thin shaft, a hook at the tip, and a ring handle. The top part of the shaft has a serrated, comb-like structure.	<p>General Retractors HIC-4644</p>	<p>0.00</p>
 A surgical retractor with a long, thin shaft, a hook at the tip, and a ring handle. The top part of the shaft has a serrated, comb-like structure.	<p>General Retractors HIC-4643</p>	<p>0.00</p>
 A surgical retractor with a long, thin shaft, a hook at the tip, and a ring handle. The top part of the shaft has a serrated, comb-like structure.	<p>General Retractors HIC-4642</p>	<p>0.00</p>





 <p>A long-handled surgical retractor with a three-pronged head.</p>	<p>General Retractors HIC-4641</p>	<p>0.00</p>
 <p>A long-handled surgical retractor with a two-pronged head.</p>	<p>General Retractors HIC-4640</p>	<p>0.00</p>
 <p>A long-handled surgical retractor with a single curved prong.</p>	<p>General Retractors HIC-4639</p>	<p>0.00</p>
 <p>A long-handled surgical retractor with a complex, multi-pronged head.</p>	<p>General Retractors HIC-4638</p>	<p>0.00</p>





 <p>A surgical retractor with a long handle and a curved, hook-like tip. A small inset image shows a different view of the tip.</p>	<p>General Retractors HIC-4637</p>	<p>0.00</p>
 <p>A surgical retractor with a long handle and a curved, hook-like tip.</p>	<p>General Retractors HIC-4636</p>	<p>0.00</p>
 <p>A surgical retractor with a long handle and a curved tip featuring a serrated or beaded edge. A small inset image shows a different view of the tip.</p>	<p>General Retractors HIC-4635</p>	<p>0.00</p>
 <p>A surgical retractor with a long handle and a curved, hook-like tip.</p>	<p>General Retractors HIC-4634</p>	<p>0.00</p>





 A surgical retractor with a long handle and a curved, hook-like tip.	General Retractors HIC-4633	0.00
 A surgical retractor with a long handle and a hook-like tip that has three small prongs or teeth.	General Retractors HIC-4632	0.00
 A surgical retractor with a long handle and a curved, hook-like tip.	General Retractors HIC-4631	0.00
 A surgical retractor with a long handle and a small, rounded hook-like tip.	General Retractors HIC-4630	0.00

	General Retractors HIC-4629	0.00
	General Retractors HIC-4629	0.00
	General Retractors HIC-4628	0.00
	General Retractors HIC-4627	0.00



 <p>A surgical retractor with a long, tapered handle and a curved, hook-like tip. Above the handle is a small diagram showing the retractor's internal mechanism with four teeth.</p>	<p>General Retractors HIC-4626</p>	<p>0.00</p>
 <p>A surgical retractor with a long, tapered handle and a curved, hook-like tip. Above the handle is a small diagram showing the retractor's internal mechanism with four teeth.</p>	<p>General Retractors HIC-4625</p>	<p>0.00</p>
 <p>A surgical retractor with a long, tapered handle and a curved, hook-like tip. Above the handle is a small diagram showing the retractor's internal mechanism with four teeth.</p>	<p>General Retractors HIC-4624</p>	<p>0.00</p>
 <p>A surgical retractor with a handle that has a circular hole at the end. The head of the retractor is wider and has a curved, hook-like tip. A small diagram above the handle shows the retractor's internal mechanism.</p>	<p>General Retractors HIC-4623</p>	<p>0.00</p>

 <p>The image shows a surgical retractor with a long, textured handle and a curved, hook-like tip. A small inset drawing shows a detail of the tip's curvature.</p>	<p>General Retractors HIC-4622</p>	<p>0.00</p>
 <p>The image shows a surgical retractor with a long, textured handle and a curved, hook-like tip. A small inset drawing shows a detail of the tip's curvature.</p>	<p>General Retractors HIC-4621</p>	<p>0.00</p>
 <p>The image shows a surgical retractor with a long, textured handle and a curved, hook-like tip.</p>	<p>General Retractors HIC-4620</p>	<p>0.00</p>
 <p>The image shows a surgical retractor with a long, textured handle and a fork-like tip with three prongs.</p>	<p>General Retractors HIC-4619</p>	<p>0.00</p>

 <p>A surgical retractor with a long handle and a head featuring four parallel, rounded prongs.</p>	<p>General Retractors HIC-4618</p>	<p>0.00</p>
 <p>A surgical retractor with a long handle and a head featuring a single curved hook.</p>	<p>General Retractors HIC-4617</p>	<p>0.00</p>
 <p>A surgical retractor with a long handle and a head featuring a single curved hook with a small 'w' and 'h' marking.</p>	<p>General Retractors HIC-4616</p>	<p>0.00</p>
 <p>A surgical retractor with a long handle and a head featuring a single curved hook with a small 'w' and 'h' marking.</p>	<p>General Retractors HIC-4615</p>	<p>0.00</p>

 <p>A surgical retractor with a long, textured handle and a curved, hook-like tip.</p>	<p>General Retractors HIC-4614</p>	<p>0.00</p>
 <p>A surgical retractor with a long, textured handle and a curved, hook-like tip.</p>	<p>General Retractors HIC-4613</p>	<p>0.00</p>
 <p>A surgical retractor with a long handle, a circular loop at the end, and a curved, hook-like tip.</p>	<p>General Retractors HIC-4612</p>	<p>0.00</p>
 <p>A surgical retractor with a long, smooth handle and a curved, hook-like tip.</p>	<p>General Retractors HIC-4611</p>	<p>0.00</p>

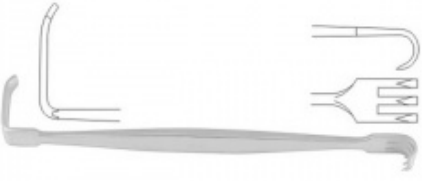
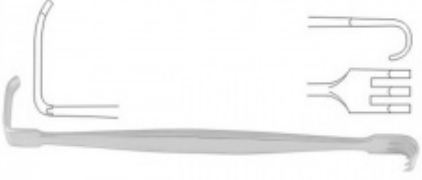

 <p>A surgical retractor with a long, thin shaft, a circular handle at the end, and a small hook-like attachment at the top.</p>	<p>General Retractors HIC-4610</p>	<p>0.00</p>
 <p>A surgical retractor with a long, thin shaft and a hook-like attachment at the top.</p>	<p>General Retractors HIC-4609</p>	<p>0.00</p>
 <p>A surgical retractor with a long, thin shaft, a circular handle at the end, and a hook-like attachment at the top.</p>	<p>General Retractors HIC-4608</p>	<p>0.00</p>
 <p>A surgical retractor with a long, thin shaft and a hook-like attachment at the top.</p>	<p>General Retractors HIC-4607</p>	<p>0.00</p>

	<p>General Retractors HIC-4606</p>	<p>0.00</p>
	<p>General Retractors HIC-4605</p>	<p>0.00</p>
	<p>General Retractors HIC-4604</p>	<p>0.00</p>
	<p>General Retractors HIC-4603</p>	<p>0.00</p>

	<p>General Retractors HIC-4602</p>	<p>0.00</p>
	<p>General Retractors HIC-4601</p>	<p>0.00</p>



Lamina Spreaders





Product Image	Product Name	Price(\$)
	<p>Lamina Spreaders HIC-4704</p>	<p>0.00</p>

	<p>Lamina Spreaders HIC-4703</p>	<p>0.00</p>
	<p>Lamina Spreaders HIC-4702</p>	<p>0.00</p>
	<p>Lamina Spreaders HIC-4701</p>	<p>0.00</p>





Laminectomy Retractor

Product Image	Product Name	Price(\$)

	<p>Laminectomy Retractor HIC-4821</p>	<p>0.00</p>
	<p>Laminectomy Retractor HIC-4820</p>	<p>0.00</p>
	<p>Laminectomy Retractor HIC-4819</p>	<p>0.00</p>
	<p>Laminectomy Retractor HIC-4818</p>	<p>0.00</p>

	<p>Laminectomy Retractor HIC-4817</p>	<p>0.00</p>
	<p>Laminectomy Retractor HIC-4816</p>	<p>0.00</p>
	<p>Laminectomy Retractor HIC-4815</p>	<p>0.00</p>
	<p>Laminectomy Retractor HIC-4814</p>	<p>0.00</p>



 A metal laminectomy retractor with two vertical posts and a horizontal base.	Laminectomy Retractor HIC-4813	0.00
 A metal laminectomy retractor with three curved blades and a central post.	Laminectomy Retractor HIC-4812	0.00
 A metal laminectomy retractor with a curved blade and a serrated edge.	Laminectomy Retractor HIC-4811	0.00
 A metal laminectomy retractor with a curved blade and two curved legs.	Laminectomy Retractor HIC-4810	0.00





	Laminectomy Retractor HIC-4809	0.00
	Laminectomy Retractor HIC-4808	0.00
	Laminectomy Retractor HIC-4807	0.00
	Laminectomy Retractor HIC-4806	0.00



 A laminectomy retractor with two curved blades and a central adjustment knob.	Laminectomy Retractor HIC-4805	0.00
 A laminectomy retractor with two curved blades and a central adjustment knob.	Laminectomy Retractor HIC-4804	0.00
 A laminectomy retractor with three curved blades and a central adjustment knob.	Laminectomy Retractor HIC-4803	0.00
 A laminectomy retractor with three curved blades and a central adjustment knob.	Laminectomy Retractor HIC-4802	0.00

	<p>Laminectomy Retractor HIC-4801</p>	<p>0.00</p>
---	---	-------------

Nasal Hooks





Product Image	Product Name	Price(\$)
	<p>Nasal Hooks HIC-4909</p>	<p>0.00</p>
	<p>Nasal Hooks HIC-4908</p>	<p>0.00</p>





 A metal nasal hook with a curved hook at the top and a long, flat base with four circular holes and a small hook at the bottom.	Nasal Hooks HIC-4907	0.00
 A metal nasal hook with a forked end and a long, textured handle with a circular hole at the end.	Nasal Hooks HIC-4906	0.00
 A metal nasal hook with a curved hook at the top and a long, thin handle.	Nasal Hooks HIC-4905	0.00
 A metal nasal hook with a curved hook at the top and a long, thin handle.	Nasal Hooks HIC-4904	0.00





	<p>Nasal Hooks HIC-4903</p>	<p>0.00</p>
	<p>Nasal Hooks HIC-4902</p>	<p>0.00</p>
	<p>Nasal Hooks HIC-4901</p>	<p>0.00</p>

Nerve Hooks

Product Image	Product Name	Price(\$)



 A long, thin, straight metal hook with a small hook at the end.	Nerve Hooks HIC-5012	0.00
 A long, thin metal hook with a small hook at the end, and a shorter, thicker hook above it.	Nerve Hooks HIC-5011	0.00
 A long, thin metal hook with a small hook at the end, and a shorter, thicker hook above it.	Nerve Hooks HIC-5010	0.00
 A long, thin metal hook with a small hook at the end, and a shorter, thicker hook above it.	Nerve Hooks HIC-5009	0.00



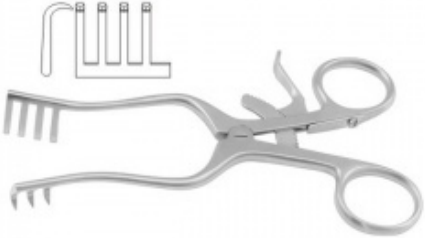
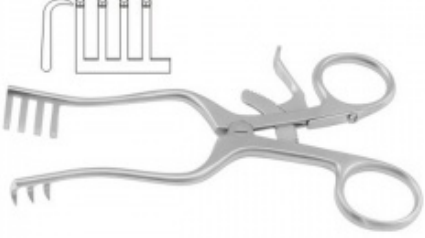
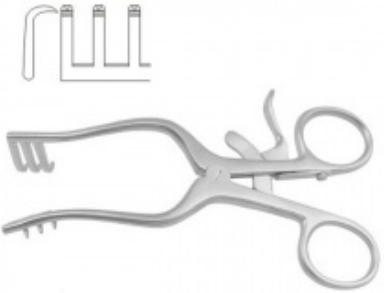

 A long, thin surgical instrument with a hook-shaped tip that curves downwards and then back up.	Nerve Hooks HIC-5008	0.00
 A long, thin surgical instrument with a hook-shaped tip that curves downwards and then back up.	Nerve Hooks HIC-5007	0.00
 A long, thin surgical instrument with a hook-shaped tip that curves downwards and then back up.	Nerve Hooks HIC-5006	0.00
 A long, thin surgical instrument with a hook-shaped tip that curves downwards and then back up.	Nerve Hooks HIC-5005	0.00

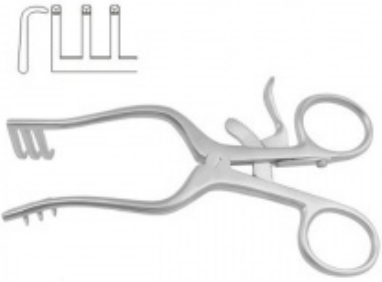
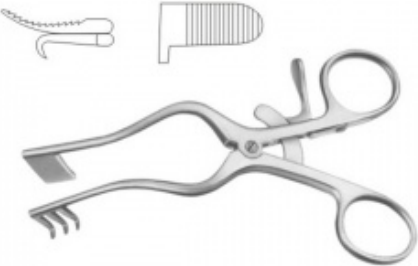
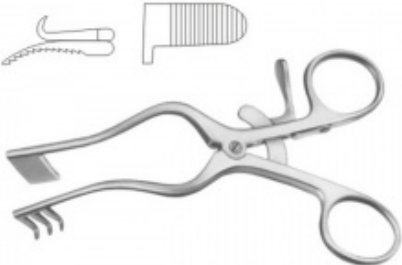

 <p>A long, thin surgical instrument with a single curved hook at the tip.</p>	<p>Nerve Hooks HIC-5004</p>	<p>0.00</p>
 <p>A long, thin surgical instrument with a single curved hook at the tip.</p>	<p>Nerve Hooks HIC-5003</p>	<p>0.00</p>
 <p>A long, thin surgical instrument with two curved hooks at the tip.</p>	<p>Nerve Hooks HIC-5002</p>	<p>0.00</p>
 <p>A long, thin surgical instrument with two curved hooks at the tip.</p>	<p>Nerve Hooks HIC-5001</p>	<p>0.00</p>

Self Retaining Retractors



Product Image	Product Name	Price(\$)
 A self-retaining retractor with a long, curved handle and a wide, flat base. The base has four vertical posts and a curved top edge. The handle has a circular grip and a small hook-like detail.	Self Retaining Retractors HIC-5133	0.00
 A self-retaining retractor with a long, curved handle and a wide, flat base. The base has four vertical posts and a curved top edge. The handle has a circular grip and a small hook-like detail.	Self Retaining Retractors HIC-5132	0.00
 A self-retaining retractor with a long, curved handle and a wide, flat base. The base has four vertical posts and a curved top edge. The handle has a circular grip and a small hook-like detail.	Self Retaining Retractors HIC-5131	0.00

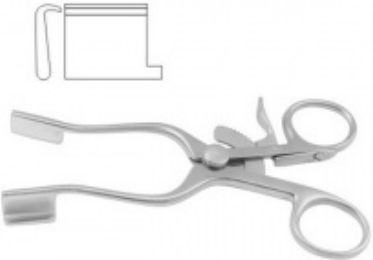
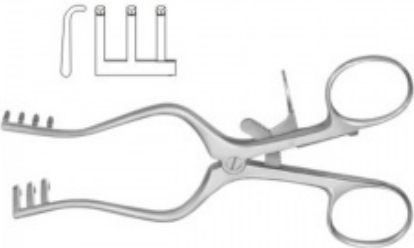

	<p>Self Retaining Retractors HIC-5130</p>	<p>0.00</p>
	<p>Self Retaining Retractors HIC-5129</p>	<p>0.00</p>
	<p>Self Retaining Retractors HIC-5128</p>	<p>0.00</p>
	<p>Self Retaining Retractors HIC-5127</p>	<p>0.00</p>

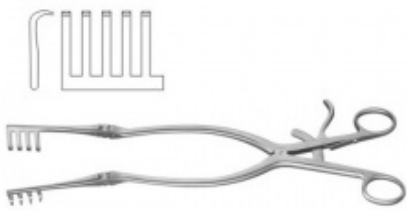
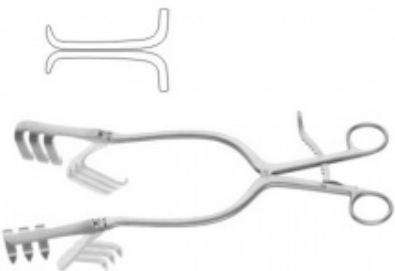
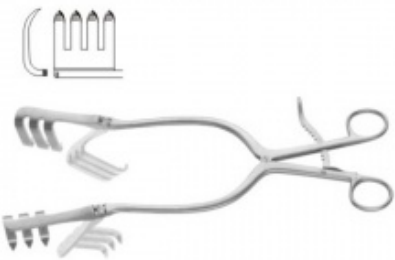
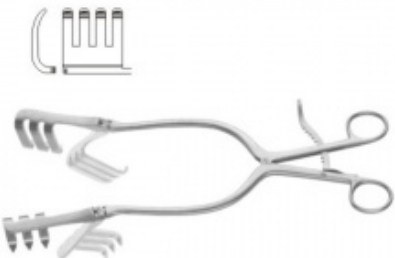
	<p>Self Retaining Retractors HIC-5126</p>	<p>0.00</p>
	<p>Self Retaining Retractors HIC-5125</p>	<p>0.00</p>
	<p>Self Retaining Retractors HIC-5124</p>	<p>0.00</p>
	<p>Self Retaining Retractors HIC-5123</p>	<p>0.00</p>

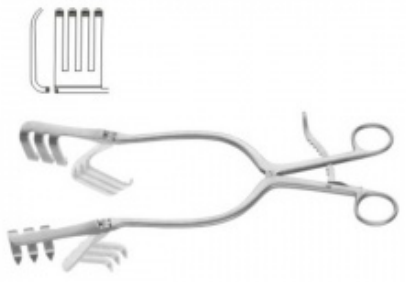
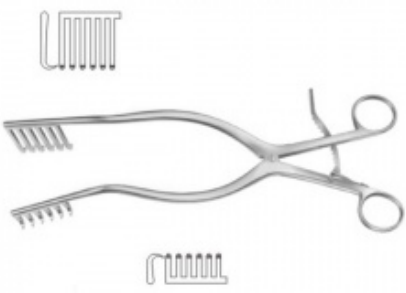
 <p>A self-retaining retractor with two long, curved arms and two circular handles. The arms have a hook-like end. Two small diagrams above the main image show the hook and the handle details.</p>	<p>Self Retaining Retractors HIC-5122</p>	<p>0.00</p>
 <p>A self-retaining retractor with two long, curved arms and two circular handles. The arms have a hook-like end. Two small diagrams above the main image show the hook and the handle details.</p>	<p>Self Retaining Retractors HIC-5121</p>	<p>0.00</p>
 <p>A self-retaining retractor with two long, curved arms and two circular handles. The arms have a hook-like end. Two small diagrams above the main image show the hook and the handle details.</p>	<p>Self Retaining Retractors HIC-5120</p>	<p>0.00</p>
 <p>A self-retaining retractor with two long, curved arms and two circular handles. The arms have a hook-like end with serrated edges. Two small diagrams above the main image show the hook and the handle details.</p>	<p>Self Retaining Retractors HIC-5119</p>	<p>0.00</p>

	<p>Self Retaining Retractors HIC-5118</p>	<p>0.00</p>
	<p>Self Retaining Retractors HIC-5117</p>	<p>0.00</p>
	<p>Self Retaining Retractors HIC-5116</p>	<p>0.00</p>
	<p>Self Retaining Retractors HIC-5115</p>	<p>0.00</p>

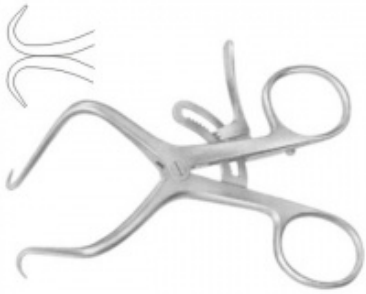
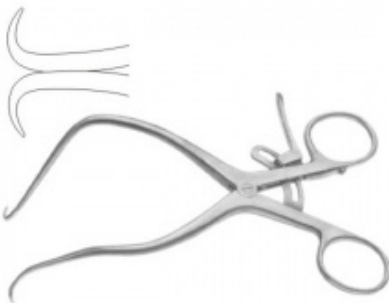
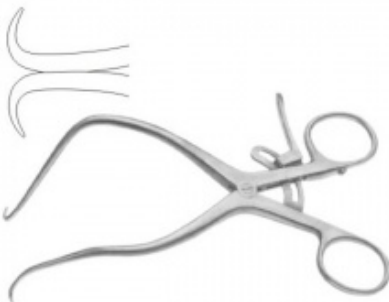
	<p>Self Retaining Retractors HIC-5114</p>	<p>0.00</p>
	<p>Self Retaining Retractors HIC-5113</p>	<p>0.00</p>
	<p>Self Retaining Retractors HIC-5112</p>	<p>0.00</p>
	<p>Self Retaining Retractors HIC-5111</p>	<p>0.00</p>

	<p>Self Retaining Retractors HIC-5110</p>	<p>0.00</p>
	<p>Self Retaining Retractors HIC-5109</p>	<p>0.00</p>
	<p>Self Retaining Retractors HIC-5108</p>	<p>0.00</p>
	<p>Self Retaining Retractors HIC-5107</p>	<p>0.00</p>

	<p>Self Retaining Retractors HIC-5106</p>	<p>0.00</p>
	<p>Self Retaining Retractors HIC-5105</p>	<p>0.00</p>
	<p>Self Retaining Retractors HIC-5104</p>	<p>0.00</p>
	<p>Self Retaining Retractors HIC-5103</p>	<p>0.00</p>





	<p>Self Retaining Retractors HIC-5102</p>	<p>0.00</p>
	<p>Self Retaining Retractors HIC-5101</p>	<p>0.00</p>



Wound Retractors





Product Image	Product Name	Price(\$)
	<p>Wound Retractors HIC-5224</p>	<p>0.00</p>





	<p>Wound Retractors HIC-5223</p>	<p>0.00</p>
	<p>Wound Retractors HIC-5222</p>	<p>0.00</p>
	<p>Wound Retractors HIC-5221</p>	<p>0.00</p>
	<p>Wound Retractors HIC-5220</p>	<p>0.00</p>

 <p>The image shows a wound retractor with a long, thin handle and a curved hook at the top. Below the handle is a separate component with three prongs.</p>	<p>Wound Retractors HIC-5219</p>	<p>0.00</p>
 <p>The image shows a wound retractor with a long, thin handle and a curved hook at the top. Below the handle is a separate component with three prongs.</p>	<p>Wound Retractors HIC-5218</p>	<p>0.00</p>
 <p>The image shows a wound retractor with a long, thin handle and a curved hook at the top. Below the handle is a separate component with three prongs.</p>	<p>Wound Retractors HIC-5217</p>	<p>0.00</p>
 <p>The image shows a wound retractor with a long, thin handle and a curved hook at the top. Below the handle is a separate component with three prongs.</p>	<p>Wound Retractors HIC-5216</p>	<p>0.00</p>



	<p>Wound Retractors HIC-5215</p>	<p>0.00</p>
	<p>Wound Retractors HIC-5214</p>	<p>0.00</p>
	<p>Wound Retractors HIC-5213</p>	<p>0.00</p>
	<p>Wound Retractors HIC-5212</p>	<p>0.00</p>





 A surgical instrument with a long handle and a hook-shaped head.	Wound Retractors HIC-5212	0.00
 A surgical instrument with a long handle and a head with four prongs.	Wound Retractors HIC-5211	0.00
 A surgical instrument with a long handle and a head with four prongs.	Wound Retractors HIC-5210	0.00
 A surgical instrument with a long handle and a head with a hook and a prong.	Wound Retractors HIC-5209	0.00

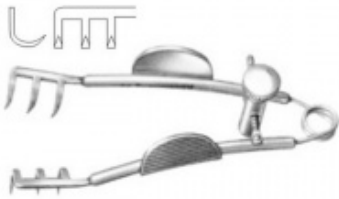

	<p>Wound Retractors HIC-5208</p>	<p>0.00</p>
	<p>Wound Retractors HIC-5207</p>	<p>0.00</p>
	<p>Wound Retractors HIC-5206</p>	<p>0.00</p>
	<p>Wound Retractors HIC-5205</p>	<p>0.00</p>



	<p>Wound Retractors HIC-5204</p>	<p>0.00</p>
	<p>Wound Retractors HIC-5203</p>	<p>0.00</p>
	<p>Wound Retractors HIC-5202</p>	<p>0.00</p>
	<p>Wound Retractors HIC-5201</p>	<p>0.00</p>

Wound Spreaders

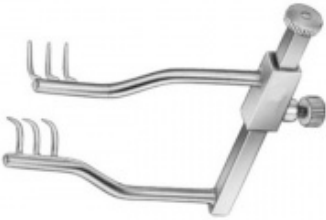
Product Image	Product Name	Price(\$)
 A metal wound spreader with two circular handles and serrated ends.	Wound Spreaders HIC-5318	0.00
 A metal wound spreader with two circular handles and serrated ends.	Wound Spreaders HIC-5317	0.00
 A metal wound spreader with two circular handles, serrated ends, and a central locking mechanism.	Wound Spreaders HIC-5316	0.00

	<p>Wound Spreaders HIC-5315</p>	<p>0.00</p>
	<p>Wound Spreaders HIC-5314</p>	<p>0.00</p>
	<p>Wound Spreaders HIC-5313</p>	<p>0.00</p>
	<p>Wound Spreaders HIC-5312</p>	<p>0.00</p>

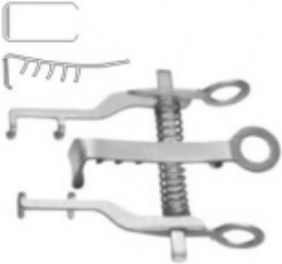
 <p>A metal wound spreader with a long, thin handle and a curved, hook-like end. It features two small circular knobs on the handle and a hook at the tip.</p>	<p>Wound Spreaders HIC-5311</p>	<p>0.00</p>
 <p>A metal wound spreader with a central handle and two curved arms. Each arm has three small, pointed teeth. The handle has a circular knob at the top.</p>	<p>Wound Spreaders HIC-5310</p>	<p>0.00</p>
 <p>A metal wound spreader with a central handle and two curved arms. Each arm has three small, pointed teeth. The handle has a circular knob at the top.</p>	<p>Wound Spreaders HIC-5309</p>	<p>0.00</p>
 <p>A metal wound spreader with a central handle and two curved arms. Each arm has three small, pointed teeth. The handle has a circular knob at the top.</p>	<p>Wound Spreaders HIC-5308</p>	<p>0.00</p>

	<p>Wound Spreaders HIC-5307</p>	<p>0.00</p>
	<p>Wound Spreaders HIC-5306</p>	<p>0.00</p>
	<p>Wound Spreaders HIC-5305</p>	<p>0.00</p>
	<p>Wound Spreaders HIC-5304</p>	<p>0.00</p>

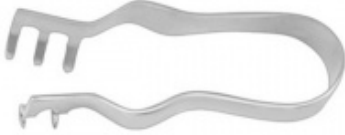
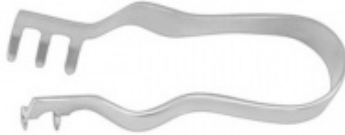



	<p>Wound Spreaders HIC-5303</p>	<p>0.00</p>
	<p>Wound Spreaders HIC-5302</p>	<p>0.00</p>
	<p>Wound Spreaders HIC-5301</p>	<p>0.00</p>

SCALPEL HANDLES & KNIVES

Amputation Knives

Product Image	Product Name	Price(\$)

 A long, thin, straight surgical knife with a single beveled edge and a simple handle.	Amputation Knives HIC-5609	0.00
 A surgical knife with a curved blade and a handle that has a slight curve at the end.	Amputation Knives HIC-5608	0.00
 A surgical knife with a curved blade and a handle that has a slight curve at the end, similar to HIC-5608 but with a different blade shape.	Amputation Knives HIC-5607	0.00
 A surgical knife with a curved blade and a handle that has a slight curve at the end, similar to HIC-5608 and HIC-5607.	Amputation Knives HIC-5606	0.00

	Amputation Knives HIC-5605	0.00
	Amputation Knives HIC-5604	0.00
	Amputation Knives HIC-5603	0.00
	Amputation Knives HIC-5602	0.00

	<p>Amputation Knives HIC-5601</p>	<p>0.00</p>
---	---------------------------------------	-------------

Aorta Punches

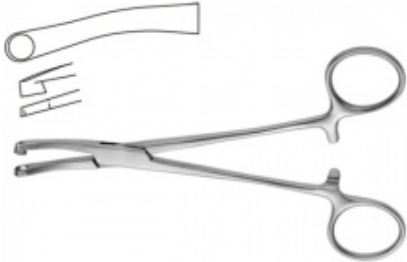
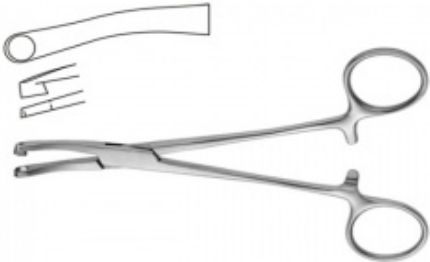
Product Image	Product Name	Price(\$)
	<p>Aorta Punches HIC-5701</p>	<p>0.00</p>
	<p>Aorta Punches HIC-5702</p>	<p>0.00</p>

Autopsy (Postmortem) Knives

Product Image	Product Name	Price(\$)

	Autopsy (Postmortem) Knives HIC-5806	0.00
	Autopsy (Postmortem) Knives HIC-5805	0.00
	Autopsy (Postmortem) Knives HIC-5804	0.00
	Autopsy (Postmortem) Knives HIC-5803	0.00

	<p>Autopsy (Postmortem) Knives HIC-5802</p>	<p>0.00</p>
	<p>Autopsy (Postmortem) Knives HIC-5801</p>	<p>0.00</p>

Blade Holders and Blade Breakers

Product Image	Product Name	Price(\$)
	<p>Blade Holders and Blade Breakers HIC-5903</p>	<p>0.00</p>

	<p>Blade Holders and Blade Breakers HIC-5902</p>	<p>0.00</p>
	<p>Blade Holders and Blade Breakers HIC-5901</p>	<p>0.00</p>



Dermatome Instrument - Skin Graft Knives



Product Image	Product Name	Price(\$)
	<p>Dermatome Instrument - Skin Graft Knives HIC-6006</p>	<p>0.00</p>





	<p>Dermatome Instrument - Skin Graft Knives HIC-6005</p>	<p>0.00</p>
	<p>Dermatome Instrument - Skin Graft Knives HIC-6004</p>	<p>0.00</p>
	<p>Dermatome Instrument - Skin Graft Knives HIC-6003</p>	<p>0.00</p>
	<p>Dermatome Instrument - Skin Graft Knives HIC-6002</p>	<p>0.00</p>

	<p>Dermatome Instrument - Skin Graft Knives HIC-6001</p>	<p>0.00</p>
---	--	-------------





Dissecting and Operating Knives





Product Image	Product Name	Price(\$)
	<p>Dissecting and Operating Knives HIC-6124</p>	<p>0.00</p>
	<p>Dissecting and Operating Knives HIC-6123</p>	<p>0.00</p>

	<p>Dissecting and Operating Knives HIC-6122</p>	<p>0.00</p>
	<p>Dissecting and Operating Knives HIC-6121</p>	<p>0.00</p>
	<p>Dissecting and Operating Knives HIC-6120</p>	<p>0.00</p>
	<p>Dissecting and Operating Knives HIC-6119</p>	<p>0.00</p>

	<p>Dissecting and Operating Knives HIC-6118</p>	<p>0.00</p>
	<p>Dissecting and Operating Knives HIC-6117</p>	<p>0.00</p>
	<p>Dissecting and Operating Knives HIC-6116</p>	<p>0.00</p>
	<p>Dissecting and Operating Knives HIC-6115</p>	<p>0.00</p>

	<p>Dissecting and Operating Knives HIC-6114</p>	<p>0.00</p>
	<p>Dissecting and Operating Knives HIC-6113</p>	<p>0.00</p>
	<p>Dissecting and Operating Knives HIC-6112</p>	<p>0.00</p>
	<p>Dissecting and Operating Knives HIC-6111</p>	<p>0.00</p>

	<p>Dissecting and Operating Knives HIC-6110</p>	<p>0.00</p>
	<p>Dissecting and Operating Knives HIC-6109</p>	<p>0.00</p>
	<p>Dissecting and Operating Knives HIC-6108</p>	<p>0.00</p>
	<p>Dissecting and Operating Knives HIC-6107</p>	<p>0.00</p>

	<p>Dissecting and Operating Knives HIC-6106</p>	<p>0.00</p>
	<p>Dissecting and Operating Knives HIC-6105</p>	<p>0.00</p>
	<p>Dissecting and Operating Knives HIC-6104</p>	<p>0.00</p>
	<p>Dissecting and Operating Knives HIC-6103</p>	<p>0.00</p>

	<p>Dissecting and Operating Knives HIC-6102</p>	<p>0.00</p>
	<p>Dissecting and Operating Knives HIC-6101</p>	<p>0.00</p>

Fistula Knives

Product Image	Product Name	Price(\$)
	<p>Fistula Knives HIC-6204</p>	<p>0.00</p>

	<p>Fistula Knives HIC-6203</p>	<p>0.00</p>
	<p>Fistula Knives HIC-6202</p>	<p>0.00</p>
	<p>Fistula Knives HIC-6201</p>	<p>0.00</p>





Knife Sharpening Stones





Product Image	Product Name	Price(\$)

	<p>Knife Sharpening Stones HIC-6302</p>	<p>0.00</p>
	<p>Knife Sharpening Stones HIC-6301</p>	<p>0.00</p>



Micro Scalpel Blades



Product Image	Product Name	Price(\$)
	<p>Micro Scalpel Blades HIC-6309</p>	<p>0.00</p>

 A line drawing of a micro scalpel blade with a curved, hook-like tip and a rectangular handle with a small notch on the right side.	Micro Scalpel Blades HIC-6308	0.00
 A line drawing of a micro scalpel blade with a straight, slightly curved tip and a rectangular handle with a small notch on the right side.	Micro Scalpel Blades HIC-6307	0.00
 A line drawing of a micro scalpel blade with a straight, slightly curved tip and a rectangular handle with a small notch on the right side.	Micro Scalpel Blades HIC-6306	0.00
 A line drawing of a micro scalpel blade with a straight, slightly curved tip and a rectangular handle with a small notch on the right side.	Micro Scalpel Blades HIC-6305	0.00

	<p>Micro Scalpel Blades HIC-6304</p>	<p>0.00</p>
	<p>Micro Scalpel Blades HIC-6303</p>	<p>0.00</p>
	<p>Micro Scalpel Blades HIC-6302</p>	<p>0.00</p>
	<p>Micro Scalpel Blades HIC-6301</p>	<p>0.00</p>

Micro Scalpel Handles

Product Image	Product Name	Price(\$)
 A micro scalpel handle with a long, thin, slightly curved blade and a short, straight handle.	Micro Scalpel Handles HIC-6406	0.00
 A micro scalpel handle with a long, thin, curved blade and a short, straight handle.	Micro Scalpel Handles HIC-6405	0.00
 A micro scalpel handle with a long, thin, straight blade and a short, straight handle.	Micro Scalpel Handles HIC-6404	0.00

	<p>Micro Scalpel Handles HIC-6403</p>	<p>0.00</p>
	<p>Micro Scalpel Handles HIC-6402</p>	<p>0.00</p>
	<p>Micro Scalpel Handles HIC-6401</p>	<p>0.00</p>

Razor Knives

Product Image	Product Name	Price(\$)





	<p>Razor Knives HIC-6502</p>	<p>0.00</p>
	<p>Razor Knives HIC-6501</p>	<p>0.00</p>



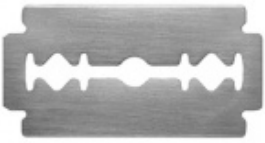

Scalpel Blade Removers



Product Image	Product Name	Price(\$)
	<p>Scalpel Blade Removers HIC-6601</p>	<p>0.00</p>

Scalpel Blades

Product Image	Product Name	Price(\$)

	<p>Scalpel Blades HIC-6618</p>	<p>0.00</p>
	<p>Scalpel Blades HIC-6617</p>	<p>0.00</p>
	<p>Scalpel Blades HIC-6616</p>	<p>0.00</p>
	<p>Scalpel Blades HIC-6615</p>	<p>0.00</p>

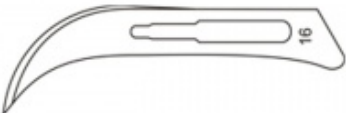

 A line drawing of a scalpel blade, model HIC-6614. The blade is curved and has a small notch at the base. The number '24' is printed on the handle.	Scalpel Blades HIC-6614	0.00
 A line drawing of a scalpel blade, model HIC-6613. The blade is curved and has a small notch at the base. The number '23' is printed on the handle.	Scalpel Blades HIC-6613	0.00
 A line drawing of a scalpel blade, model HIC-6612. The blade is curved and has a small notch at the base. The number '22' is printed on the handle.	Scalpel Blades HIC-6612	0.00
 A line drawing of a scalpel blade, model HIC-6611. The blade is curved and has a small notch at the base. The number '21' is printed on the handle.	Scalpel Blades HIC-6611	0.00

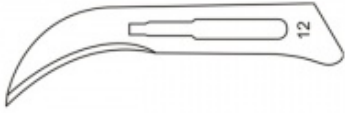
 A line drawing of a scalpel blade, model HIC-6610. The blade is curved and has a central slot for the handle. The number '20' is printed on the right side of the blade.	<p>Scalpel Blades HIC-6610</p>	<p>0.00</p>
 A line drawing of a scalpel blade, model HIC-6609. The blade is curved and has a central slot for the handle. The number '19' is printed on the right side of the blade.	<p>Scalpel Blades HIC-6609</p>	<p>0.00</p>
 A line drawing of a scalpel blade, model HIC-6608. The blade is curved and has a central slot for the handle. The number '18' is printed on the right side of the blade.	<p>Scalpel Blades HIC-6608</p>	<p>0.00</p>
 A line drawing of a scalpel blade, model HIC-6607. The blade is curved and has a central slot for the handle. The number '16' is printed on the right side of the blade.	<p>Scalpel Blades HIC-6607</p>	<p>0.00</p>





 A line drawing of a scalpel blade with a curved, hook-like tip and a handle with a central slot. The number '15' is printed on the handle.	Scalpel Blades HIC-6605	0.00
 A line drawing of a scalpel blade with a straight, pointed tip and a handle with a central slot. The number '13' is printed on the handle.	Scalpel Blades HIC-6604	0.00
 A line drawing of a scalpel blade with a curved, hook-like tip and a handle with a central slot. The number '12' is printed on the handle.	Scalpel Blades HIC-6603	0.00
 A line drawing of a scalpel blade with a straight, pointed tip and a handle with a central slot. The number '11' is printed on the handle.	Scalpel Blades HIC-6602	0.00

	<p>Scalpel Blades HIC-6601</p>	<p>0.00</p>
---	------------------------------------	-------------

Scalpel Handles

Product Image	Product Name	Price(\$)
	<p>Scalpel Handles HIC-6715</p>	<p>0.00</p>
	<p>Scalpel Handles HIC-6714</p>	<p>0.00</p>



	Scalpel Handles HIC-6713	0.00
	Scalpel Handles HIC-6712	0.00
	Scalpel Handles HIC-6711	0.00
	Scalpel Handles HIC-6710	0.00

	<p>Scalpel Handles HIC-6709</p>	<p>0.00</p>
	<p>Scalpel Handles HIC-6708</p>	<p>0.00</p>
	<p>Scalpel Handles HIC-6707</p>	<p>0.00</p>
	<p>Scalpel Handles HIC-6706</p>	<p>0.00</p>

	Scalpel Handles HIC-6705	0.00
	Scalpel Handles HIC-6704	0.00
	Scalpel Handles HIC-6703	0.00
	Scalpel Handles HIC-6702	0.00



	<p>Scalpel Handles HIC-6701</p>	<p>0.00</p>
---	-------------------------------------	-------------

Tonsil and Cartilage Knives

Product Image	Product Name	Price(\$)
	<p>Tonsil and Cartilage Knives HIC-6802</p>	<p>0.00</p>
	<p>Tonsil and Cartilage Knives HIC-6801</p>	<p>0.00</p>

Trigeminal Knives

Product Image	Product Name	Price(\$)





	<p>Trigeminal Knives HIC-6902</p>	<p>0.00</p>
	<p>Trigeminal Knives HIC-6901</p>	<p>0.00</p>





SCISSORS

Bandage Scissors

Product Image	Product Name	Price(\$)
	<p>Bandage Scissors HIC-7118</p>	<p>0.00</p>

 A pair of bandage scissors with black handles and silver blades, shown in an open position.	Bandage Scissors HIC-7117	0.00
 A pair of bandage scissors with black handles and silver blades, shown in an open position.	Bandage Scissors HIC-7116	0.00
 A pair of bandage scissors with black handles and silver blades, shown in an open position.	Bandage Scissors HIC-7115	0.00
 A pair of bandage scissors with black handles and silver blades, shown in an open position.	Bandage Scissors HIC-7114	0.00

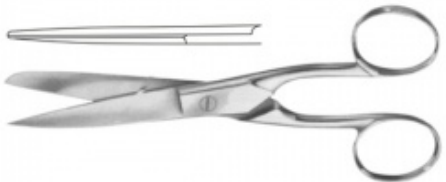
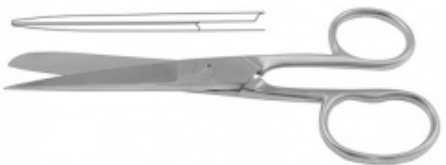
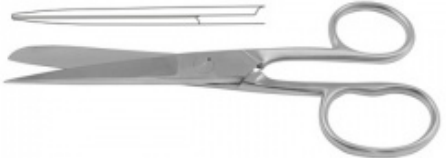

	<p>Bandage Scissors HIC-7113</p>	<p>0.00</p>
	<p>Bandage Scissors HIC-7112</p>	<p>0.00</p>
	<p>Bandage Scissors HIC-7111</p>	<p>0.00</p>
	<p>Bandage Scissors HIC-7110</p>	<p>0.00</p>

	<p>Bandage Scissors HIC-7109</p>	<p>0.00</p>
	<p>Bandage Scissors HIC-7108</p>	<p>0.00</p>
	<p>Bandage Scissors HIC-7107</p>	<p>0.00</p>
	<p>Bandage Scissors HIC-7106</p>	<p>0.00</p>

	<p>Bandage Scissors HIC-7105</p>	<p>0.00</p>
	<p>Bandage Scissors HIC-7104</p>	<p>0.00</p>
	<p>Bandage Scissors HIC-7103</p>	<p>0.00</p>
	<p>Bandage Scissors HIC-7102</p>	<p>0.00</p>



	<p>Bandage Scissors HIC-7101</p>	<p>0.00</p>
---	--------------------------------------	-------------

Bone and Septum Shears

Product Image	Product Name	Price(\$)
	<p>Bone and Septum Shears HIC-7202</p>	<p>0.00</p>
	<p>Bone and Septum Shears HIC-7201</p>	<p>0.00</p>

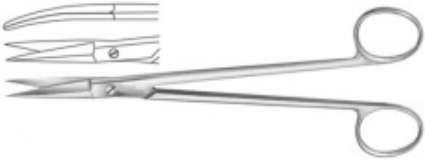

Cartilage Scissors





Product Image	Product Name	Price(\$)



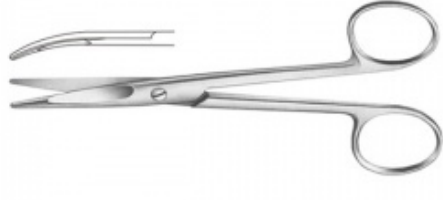

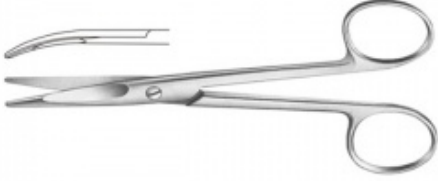
	<p>Cartilage Scissors HIC-7303</p>	<p>0.00</p>
	<p>Cartilage Scissors HIC-7302</p>	<p>0.00</p>
	<p>Cartilage Scissors HIC-7301</p>	<p>0.00</p>





Dissecting Scissors



Product Image	Product Name	Price(\$)





	<p>Dissecting Scissors HIC-7430</p>	<p>0.00</p>
	<p>Dissecting Scissors HIC-7429</p>	<p>0.00</p>
	<p>Dissecting Scissors HIC-7428</p>	<p>0.00</p>
	<p>Dissecting Scissors HIC-7427</p>	<p>0.00</p>



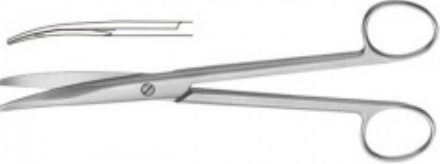
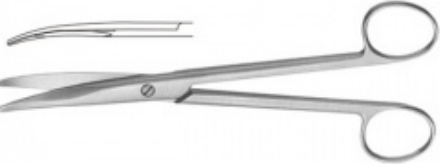

 A pair of long-handled, curved dissection scissors with a small inset image showing the sharp, pointed tips.	Dissecting Scissors HIC-7426	0.00
 A pair of long-handled, curved dissection scissors with a small inset image showing the sharp, pointed tips.	Dissecting Scissors HIC-7425	0.00
 A pair of long-handled, curved dissection scissors with a small inset image showing the sharp, pointed tips.	Dissecting Scissors HIC-7424	0.00
 A pair of long-handled, curved dissection scissors with a small inset image showing the sharp, pointed tips.	Dissecting Scissors HIC-7423	0.00



 <p>A pair of stainless steel dissection scissors with long handles and curved blades. A small inset image shows the sharp, pointed tips of the blades.</p>	<p>Dissecting Scissors HIC-7422</p>	<p>0.00</p>
 <p>A pair of stainless steel dissection scissors with long handles and curved blades. A small inset image shows the sharp, pointed tips of the blades.</p>	<p>Dissecting Scissors HIC-7421</p>	<p>0.00</p>
 <p>A pair of stainless steel dissection scissors with long handles and curved blades. A small inset image shows the sharp, pointed tips of the blades.</p>	<p>Dissecting Scissors HIC-7420</p>	<p>0.00</p>
 <p>A pair of stainless steel dissection scissors with long handles and curved blades. A small inset image shows the sharp, pointed tips of the blades.</p>	<p>Dissecting Scissors HIC-7419</p>	<p>0.00</p>

 A pair of long-handled, straight-tipped dissection scissors with a small circular logo on the upper handle.	Dissecting Scissors HIC-7418	0.00
 A pair of long-handled, straight-tipped dissection scissors with a small circular logo on the upper handle.	Dissecting Scissors HIC-7417	0.00
 A pair of long-handled, straight-tipped dissection scissors with a small circular logo on the upper handle.	Dissecting Scissors HIC-7416	0.00
 A pair of long-handled, straight-tipped dissection scissors with a small circular logo on the upper handle.	Dissecting Scissors HIC-7415	0.00

 <p>A pair of long-handled dissection scissors with curved tips and a small inset image showing the handle detail.</p>	<p>Dissecting Scissors HIC-7414</p>	<p>0.00</p>
 <p>A pair of long-handled dissection scissors with curved tips and a small inset image showing the handle detail.</p>	<p>Dissecting Scissors HIC-7413</p>	<p>0.00</p>
 <p>A pair of long-handled dissection scissors with curved tips and a small inset image showing the handle detail.</p>	<p>Dissecting Scissors HIC-7412</p>	<p>0.00</p>
 <p>A pair of long-handled dissection scissors with curved tips and a small inset image showing the handle detail.</p>	<p>Dissecting Scissors HIC-7411</p>	<p>0.00</p>

 <p>A pair of long-handled, straight-tipped dissection scissors with a central pivot and a small circular logo on the blade.</p>	<p>Dissecting Scissors HIC-7410</p>	<p>0.00</p>
 <p>A pair of long-handled, straight-tipped dissection scissors with a central pivot and a small circular logo on the blade.</p>	<p>Dissecting Scissors HIC-7409</p>	<p>0.00</p>
 <p>A pair of long-handled, curved-tipped dissection scissors with a central pivot and a small circular logo on the blade.</p>	<p>Dissecting Scissors HIC-7408</p>	<p>0.00</p>
 <p>A pair of long-handled, curved-tipped dissection scissors with a central pivot and a small circular logo on the blade.</p>	<p>Dissecting Scissors HIC-7407</p>	<p>0.00</p>



 A pair of large, curved dissection scissors with two finger loops. To the left of the scissors are three smaller surgical instruments: a pair of forceps, a pair of tweezers, and a pair of needle holders.	<p>Dissecting Scissors HIC-7406</p>	<p>0.00</p>
 A pair of large, curved dissection scissors with two finger loops. To the left of the scissors are three smaller surgical instruments: a pair of forceps, a pair of tweezers, and a pair of needle holders.	<p>Dissecting Scissors HIC-7405</p>	<p>0.00</p>
 A pair of large, curved dissection scissors with two finger loops. To the left of the scissors are three smaller surgical instruments: a pair of forceps, a pair of tweezers, and a pair of needle holders.	<p>Dissecting Scissors HIC-7404</p>	<p>0.00</p>
 A pair of large, curved dissection scissors with two finger loops. To the left of the scissors are three smaller surgical instruments: a pair of forceps, a pair of tweezers, and a pair of needle holders.	<p>Dissecting Scissors HIC-7403</p>	<p>0.00</p>

	<p>Dissecting Scissors HIC-7402</p>	<p>0.00</p>
	<p>Dissecting Scissors HIC-7401</p>	<p>0.00</p>

Enterotomy and Rectal Scissors

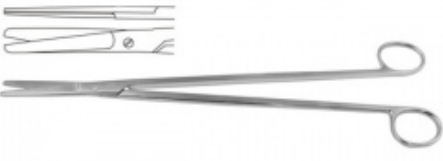
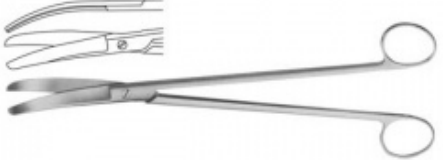
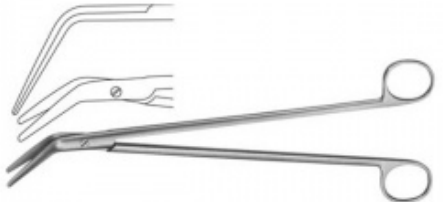

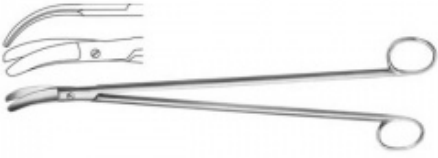
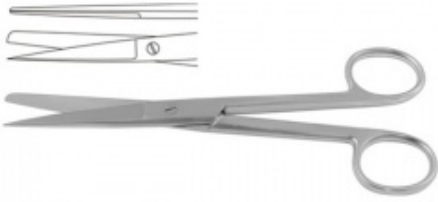
Product Image	Product Name	Price(\$)
	<p>Enterotomy and Rectal Scissors HIC-7508</p>	<p>0.00</p>

	<p>Enterotomy and Rectal Scissors HIC-7507</p>	<p>0.00</p>
	<p>Enterotomy and Rectal Scissors HIC-7506</p>	<p>0.00</p>
	<p>Enterotomy and Rectal Scissors HIC-7505</p>	<p>0.00</p>
	<p>Enterotomy and Rectal Scissors HIC-7504</p>	<p>0.00</p>

	<p>Enterotomy and Rectal Scissors HIC-7503</p>	<p>0.00</p>
	<p>Enterotomy and Rectal Scissors HIC-7502</p>	<p>0.00</p>
	<p>Enterotomy and Rectal Scissors HIC-7501</p>	<p>0.00</p>





Episiotomy Scissors

Product Image	Product Name	Price(\$)

	<p>Episiotomy Scissors HIC-7603</p>	<p>0.00</p>
	<p>Episiotomy Scissors HIC-7602</p>	<p>0.00</p>
	<p>Episiotomy Scissors HIC-7601</p>	<p>0.00</p>



Face-Lift Scissors

Product Image	Product Name	Price(\$)

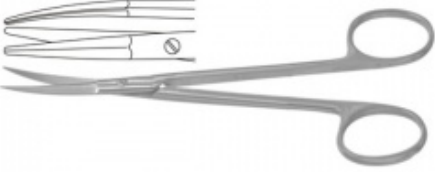
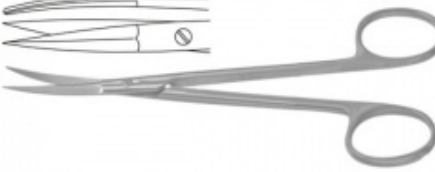
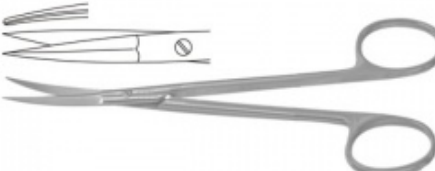
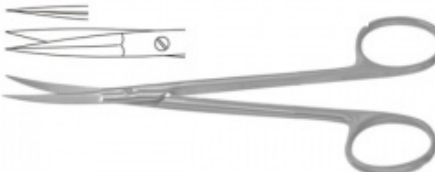
	<p>Face-Lift Scissors HIC-7708</p>	<p>0.00</p>
	<p>Face-Lift Scissors HIC-7707</p>	<p>0.00</p>
	<p>Face-Lift Scissors HIC-7706</p>	<p>0.00</p>
	<p>Face-Lift Scissors HIC-7705</p>	<p>0.00</p>

	<p>Face-Lift Scissors HIC-7704</p>	<p>0.00</p>
	<p>Face-Lift Scissors HIC-7703</p>	<p>0.00</p>
	<p>Face-Lift Scissors HIC-7702</p>	<p>0.00</p>
	<p>Face-Lift Scissors HIC-7701</p>	<p>0.00</p>



Gum Scissors

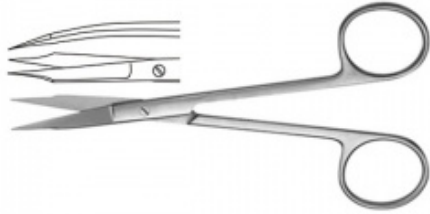
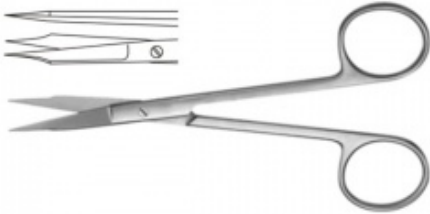

Product Image	Product Name	Price(\$)
 A pair of long-handled surgical scissors with a curved blade and a locking mechanism.	Gum Scissors HIC-7806	0.00
 A pair of long-handled surgical scissors with a curved blade and a locking mechanism.	Gum Scissors HIC-7805	0.00
 A pair of long-handled surgical scissors with a curved blade and a locking mechanism.	Gum Scissors HIC-7804	0.00

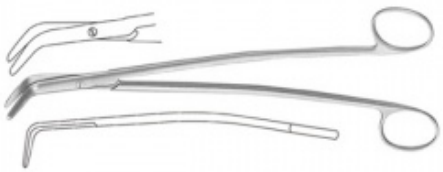
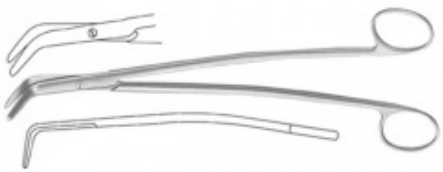

	<p>Gum Scissors HIC-7803</p>	<p>0.00</p>
	<p>Gum Scissors HIC-7802</p>	<p>0.00</p>
	<p>Gum Scissors HIC-7801</p>	<p>0.00</p>

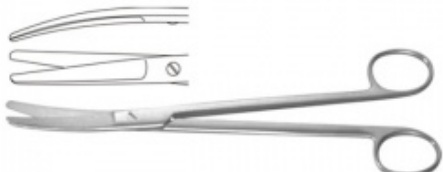

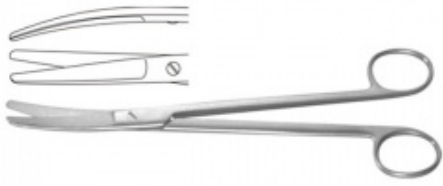
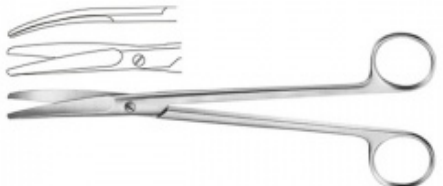
Gynecological Scissors

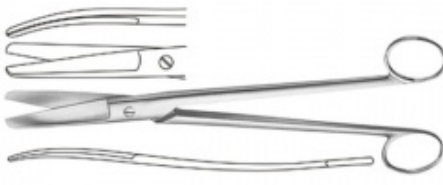
Product Image	Product Name	Price(\$)

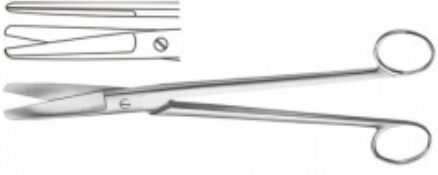
	<p>Gynecological Scissors HIC-7915</p>	<p>0.00</p>
	<p>Gynecological Scissors HIC-7914</p>	<p>0.00</p>
	<p>Gynecological Scissors HIC-7913</p>	<p>0.00</p>
	<p>Gynecological Scissors HIC-7912</p>	<p>0.00</p>

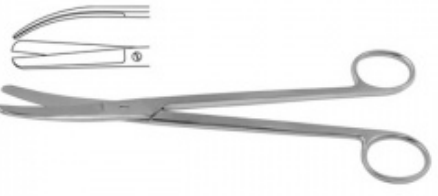

	<p>Gynecological Scissors HIC-7911</p>	<p>0.00</p>
	<p>Gynecological Scissors HIC-7910</p>	<p>0.00</p>
	<p>Gynecological Scissors HIC-7909</p>	<p>0.00</p>
	<p>Gynecological Scissors HIC-7908</p>	<p>0.00</p>



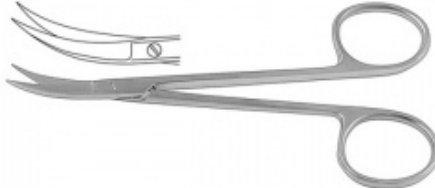

	<p>Gynecological Scissors HIC-7907</p>	<p>0.00</p>
	<p>Gynecological Scissors HIC-7906</p>	<p>0.00</p>
	<p>Gynecological Scissors HIC-7905</p>	<p>0.00</p>
	<p>Gynecological Scissors HIC-7904</p>	<p>0.00</p>

	<p>Gynecological Scissors HIC-7903</p>	<p>0.00</p>
	<p>Gynecological Scissors HIC-7902</p>	<p>0.00</p>
	<p>Gynecological Scissors HIC-7901</p>	<p>0.00</p>

Iris Scissors



Product Image	Product Name	Price(\$)

 A pair of surgical iris scissors with long, straight handles and curved blades. The blades are slightly curved and have a small notch at the tip. The handles are long and have a circular loop at the end.	<p>Iris Scissors HIC-8009</p>	<p>0.00</p>
 A pair of surgical iris scissors with long, straight handles and curved blades. The blades are slightly curved and have a small notch at the tip. The handles are long and have a circular loop at the end.	<p>Iris Scissors HIC-8008</p>	<p>0.00</p>
 A pair of surgical iris scissors with long, straight handles and curved blades. The blades are slightly curved and have a small notch at the tip. The handles are long and have a circular loop at the end.	<p>Iris Scissors HIC-8007</p>	<p>0.00</p>
 A pair of surgical iris scissors with long, straight handles and curved blades. The blades are slightly curved and have a small notch at the tip. The handles are long and have a circular loop at the end.	<p>Iris Scissors HIC-8006</p>	<p>0.00</p>

	Iris Scissors HIC-8005	0.00
	Iris Scissors HIC-8004	0.00
	Iris Scissors HIC-8003	0.00
	Iris Scissors HIC-8002	0.00





	<p>Iris Scissors HIC-8001</p>	<p>0.00</p>
---	-----------------------------------	-------------





Micro Ophthalmic Scissors





Product Image	Product Name	Price(\$)
	<p>Micro Ophthalmic Scissors HIC-8127</p>	<p>0.00</p>
	<p>Micro Ophthalmic Scissors HIC-8126</p>	<p>0.00</p>





	<p>Micro Ophthalmic Scissors HIC-8125</p>	<p>0.00</p>
	<p>Micro Ophthalmic Scissors HIC-8124</p>	<p>0.00</p>
	<p>Micro Ophthalmic Scissors HIC-8123</p>	<p>0.00</p>
	<p>Micro Ophthalmic Scissors HIC-8122</p>	<p>0.00</p>

	<p>Micro Ophthalmic Scissors HIC-8121</p>	<p>0.00</p>
	<p>Micro Ophthalmic Scissors HIC-1820</p>	<p>0.00</p>
	<p>Micro Ophthalmic Scissors HIC-1819</p>	<p>0.00</p>
	<p>Micro Ophthalmic Scissors HIC-8118</p>	<p>0.00</p>

	<p>Micro Ophthalmic Scissors HIC-8117</p>	<p>0.00</p>
	<p>Micro Ophthalmic Scissors HIC-8116</p>	<p>0.00</p>
	<p>Micro Ophthalmic Scissors HIC-8115</p>	<p>0.00</p>
	<p>Micro Ophthalmic Scissors HIC-8114</p>	<p>0.00</p>



	<p>Micro Ophthalmic Scissors HIC-8113</p>	<p>0.00</p>
	<p>Micro Ophthalmic Scissors HIC-8112</p>	<p>0.00</p>
	<p>Micro Ophthalmic Scissors HIC-8111</p>	<p>0.00</p>
	<p>Micro Ophthalmic Scissors HIC-8110</p>	<p>0.00</p>





	<p>Micro Ophthalmic Scissors HIC-8109</p>	<p>0.00</p>
	<p>Micro Ophthalmic Scissors HIC-8108</p>	<p>0.00</p>
	<p>Micro Ophthalmic Scissors HIC-8107</p>	<p>0.00</p>
	<p>Micro Ophthalmic Scissors HIC-8106</p>	<p>0.00</p>



	<p>Micro Ophthalmic Scissors HIC-8105</p>	<p>0.00</p>
	<p>Micro Ophthalmic Scissors HIC-8104</p>	<p>0.00</p>
	<p>Micro Ophthalmic Scissors HIC-8103</p>	<p>0.00</p>
	<p>Micro Ophthalmic Scissors HIC-8102</p>	<p>0.00</p>





	<p>Micro Ophthalmic Scissors HIC-8101</p>	<p>0.00</p>
---	---	-------------





Micro Scissors



Product Image	Product Name	Price(\$)
	<p>Micro Scissors HIC-8230</p>	<p>0.00</p>
	<p>Micro Scissors HIC-8229</p>	<p>0.00</p>



	<p>Micro Scissors HIC-8228</p>	<p>0.00</p>
	<p>Micro Scissors HIC-8227</p>	<p>0.00</p>
	<p>Micro Scissors HIC-8226</p>	<p>0.00</p>
	<p>Micro Scissors HIC-8225</p>	<p>0.00</p>



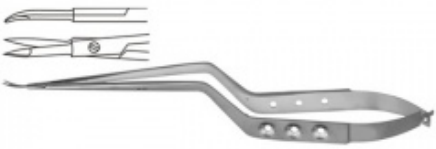

	Micro Scissors HIC-8224	0.00
	Micro Scissors HIC-8223	0.00
	Micro Scissors HIC-8222	0.00
	Micro Scissors HIC-8221	0.00

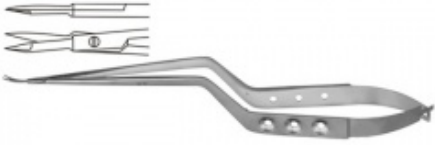
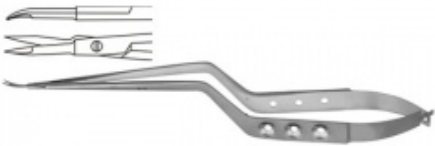
	<p>Micro Scissors HIC-8220</p>	<p>0.00</p>
	<p>Micro Scissors HIC-8219</p>	<p>0.00</p>
	<p>Micro Scissors HIC-8218</p>	<p>0.00</p>
	<p>Micro Scissors HIC-8217</p>	<p>0.00</p>



 A pair of micro scissors with long, thin handles and small, pointed blades. The handles have a textured grip area near the pivot.	<p>Micro Scissors HIC-8216</p>	<p>0.00</p>
 A pair of micro scissors with long, thin handles and small, pointed blades. The handles have a textured grip area near the pivot.	<p>Micro Scissors HIC-8215</p>	<p>0.00</p>
 A pair of micro scissors with long, thin handles and small, pointed blades. The handles have a textured grip area near the pivot.	<p>Micro Scissors HIC-8214</p>	<p>0.00</p>
 A pair of micro scissors with long, thin handles and small, pointed blades. The handles have a textured grip area near the pivot.	<p>Micro Scissors HIC-8213</p>	<p>0.00</p>





	<p>Micro Scissors HIC-8212</p>	<p>0.00</p>
	<p>Micro Scissors HIC-8211</p>	<p>0.00</p>
	<p>Micro Scissors HIC-8210</p>	<p>0.00</p>
	<p>Micro Scissors HIC-8209</p>	<p>0.00</p>

	<p>Micro Scissors HIC-8208</p>	<p>0.00</p>
	<p>Micro Scissors HIC-8207</p>	<p>0.00</p>
	<p>Micro Scissors HIC-8206</p>	<p>0.00</p>
	<p>Micro Scissors HIC-8205</p>	<p>0.00</p>





	<p>Micro Scissors HIC-8204</p>	<p>0.00</p>
	<p>Micro Scissors HIC-8203</p>	<p>0.00</p>
	<p>Micro Scissors HIC-8202</p>	<p>0.00</p>
	<p>Micro Scissors HIC-8201</p>	<p>0.00</p>





Micro Vascular Scissors





Product Image	Product Name	Price(\$)
	Micro Vascular Scissors HIC-8333	0.00
	Micro Vascular Scissors HIC-8332	0.00
	Micro Vascular Scissors HIC-8331	0.00





	<p>Micro Vascular Scissors HIC-8330</p>	<p>0.00</p>
	<p>Micro Vascular Scissors HIC-8329</p>	<p>0.00</p>
	<p>Micro Vascular Scissors HIC-8328</p>	<p>0.00</p>
	<p>Micro Vascular Scissors HIC-8327</p>	<p>0.00</p>





	<p>Micro Vascular Scissors HIC-8326</p>	<p>0.00</p>
	<p>Micro Vascular Scissors HIC-8325</p>	<p>0.00</p>
	<p>Micro Vascular Scissors HIC-8324</p>	<p>0.00</p>
	<p>Micro Vascular Scissors HIC-8323</p>	<p>0.00</p>



	<p>Micro Vascular Scissors HIC-8322</p>	<p>0.00</p>
	<p>Micro Vascular Scissors HIC-8321</p>	<p>0.00</p>
	<p>Micro Vascular Scissors HIC-8320</p>	<p>0.00</p>
	<p>Micro Vascular Scissors HIC-8319</p>	<p>0.00</p>

 <p>A pair of microvascular scissors with long, thin handles and fine serrations on the blades. A small inset diagram shows the scissors in an open position.</p>	<p>Micro Vascular Scissors HIC-8318</p>	<p>0.00</p>
 <p>A pair of microvascular scissors with long, thin handles and fine serrations on the blades. A small inset diagram shows the scissors in an open position.</p>	<p>Micro Vascular Scissors HIC-8317</p>	<p>0.00</p>
 <p>A pair of microvascular scissors with long, thin handles and fine serrations on the blades. A small inset diagram shows the scissors in an open position.</p>	<p>Micro Vascular Scissors HIC-8316</p>	<p>0.00</p>
 <p>A pair of microvascular scissors with long, thin handles and fine serrations on the blades. A small inset diagram shows the scissors in an open position.</p>	<p>Micro Vascular Scissors HIC-8315</p>	<p>0.00</p>

	<p>Micro Vascular Scissors HIC-8314</p>	<p>0.00</p>
	<p>Micro Vascular Scissors HIC-8313</p>	<p>0.00</p>
	<p>Micro Vascular Scissors HIC-8312</p>	<p>0.00</p>
	<p>Micro Vascular Scissors HIC-8311</p>	<p>0.00</p>



 A pair of microvascular scissors with long, thin handles and curved, pointed tips. The handles are joined at a central pivot point. The tips are designed for precise cutting of small vessels.	<p>Micro Vascular Scissors HIC-8310</p>	<p>0.00</p>
 A pair of microvascular scissors with long, thin handles and curved, pointed tips. The handles are joined at a central pivot point. The tips are designed for precise cutting of small vessels.	<p>Micro Vascular Scissors HIC-8309</p>	<p>0.00</p>
 A pair of microvascular scissors with long, thin handles and curved, pointed tips. The handles are joined at a central pivot point. The tips are designed for precise cutting of small vessels.	<p>Micro Vascular Scissors HIC-8308</p>	<p>0.00</p>
 A pair of microvascular scissors with long, thin handles and curved, pointed tips. The handles are joined at a central pivot point. The tips are designed for precise cutting of small vessels.	<p>Micro Vascular Scissors HIC-8307</p>	<p>0.00</p>





	<p>Micro Vascular Scissors HIC-8306</p>	<p>0.00</p>
	<p>Micro Vascular Scissors HIC-8305</p>	<p>0.00</p>
	<p>Micro Vascular Scissors HIC-8304</p>	<p>0.00</p>
	<p>Micro Vascular Scissors HIC-8303</p>	<p>0.00</p>

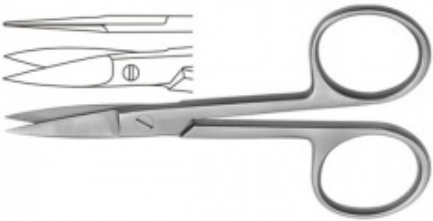

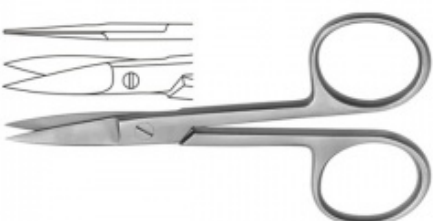
	<p>Micro Vascular Scissors HIC-8302</p>	<p>0.00</p>
	<p>Micro Vascular Scissors HIC-8301</p>	<p>0.00</p>

Nail Scissors



Product Image	Product Name	Price(\$)
	<p>Nail Scissors HIC-8412</p>	<p>0.00</p>

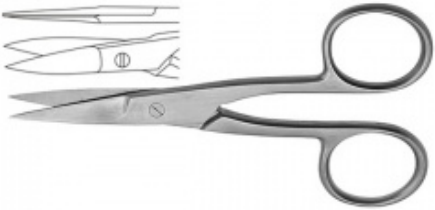
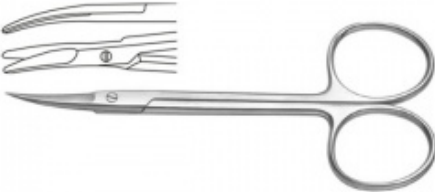
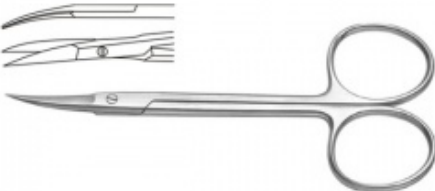



 A pair of nail scissors with curved blades and a small, pointed side blade. The handles are simple loops.	<p>Nail Scissors HIC-8411</p>	<p>0.00</p>
 A pair of nail scissors with curved blades and a small, pointed side blade. The handles are simple loops.	<p>Nail Scissors HIC-8410</p>	<p>0.00</p>
 A pair of nail scissors with curved blades and a small, pointed side blade. The handles are simple loops.	<p>Nail Scissors HIC-8409</p>	<p>0.00</p>
 A pair of nail scissors with curved blades and a small, pointed side blade. The handles are simple loops.	<p>Nail Scissors HIC-8408</p>	<p>0.00</p>



 A pair of stainless steel nail scissors with curved handles and pointed blades. A small inset image in the top left corner shows a close-up of the blades cutting through a nail.	<p>Nail Scissors HIC-8408</p>	<p>0.00</p>
 A pair of stainless steel nail scissors with curved handles and pointed blades. A small inset image in the top left corner shows a close-up of the blades cutting through a nail.	<p>Nail Scissors HIC-8407</p>	<p>0.00</p>
 A pair of stainless steel nail scissors with curved handles and pointed blades. A small inset image in the top left corner shows a close-up of the blades cutting through a nail.	<p>Nail Scissors HIC-8406</p>	<p>0.00</p>
 A pair of stainless steel nail scissors with curved handles and pointed blades. A small inset image in the top left corner shows a close-up of the blades cutting through a nail.	<p>Nail Scissors HIC-8405</p>	<p>0.00</p>

 A pair of stainless steel nail scissors with curved handles and pointed blades. To the left of the main image are three smaller, semi-transparent versions of the same scissors, slightly offset to show different angles.	<p>Nail Scissors HIC-8404</p>	<p>0.00</p>
 A pair of stainless steel nail scissors with curved handles and pointed blades. To the left of the main image are three smaller, semi-transparent versions of the same scissors, slightly offset to show different angles.	<p>Nail Scissors HIC-8403</p>	<p>0.00</p>
 A pair of stainless steel nail scissors with curved handles and pointed blades. To the left of the main image are three smaller, semi-transparent versions of the same scissors, slightly offset to show different angles.	<p>Nail Scissors HIC-8402</p>	<p>0.00</p>
 A pair of stainless steel nail scissors with curved handles and pointed blades. To the left of the main image are three smaller, semi-transparent versions of the same scissors, slightly offset to show different angles.	<p>Nail Scissors HIC-8401</p>	<p>0.00</p>

Nasal Scissors

Product Image	Product Name	Price(\$)
 A pair of long-handled nasal scissors with curved tips and a locking mechanism. A smaller inset image shows the tips of the scissors.	Nasal Scissors HIC-8509	0.00
 A pair of long-handled nasal scissors with curved tips and a locking mechanism. A smaller inset image shows the tips of the scissors.	Nasal Scissors HIC-8508	0.00
 A pair of long-handled nasal scissors with curved tips and a locking mechanism. A smaller inset image shows the tips of the scissors.	Nasal Scissors HIC-8507	0.00





	<p>Nasal Scissors HIC-8506</p>	<p>0.00</p>
	<p>Nasal Scissors HIC-8505</p>	<p>0.00</p>
	<p>Nasal Scissors HIC-8504</p>	<p>0.00</p>
	<p>Nasal Scissors HIC-8503</p>	<p>0.00</p>

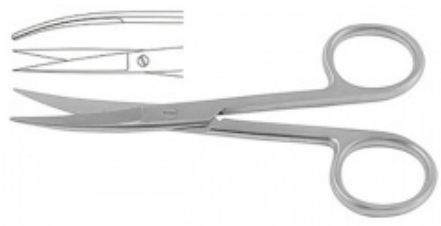

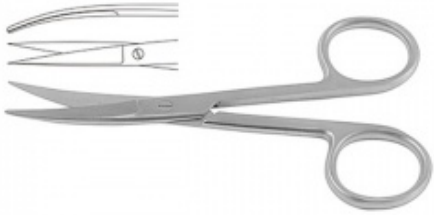
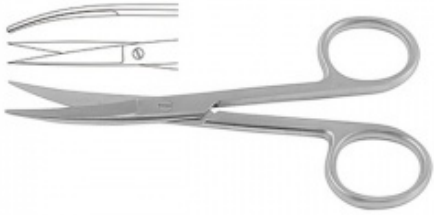
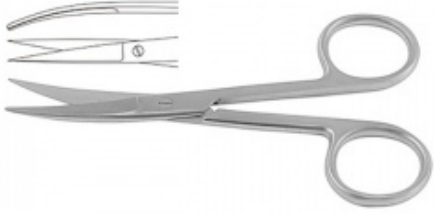
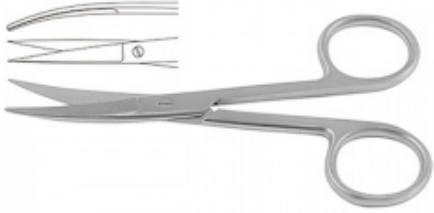
	<p>Nasal Scissors HIC-8502</p>	<p>0.00</p>
	<p>Nasal Scissors HIC-8501</p>	<p>0.00</p>

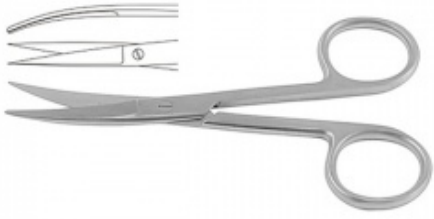

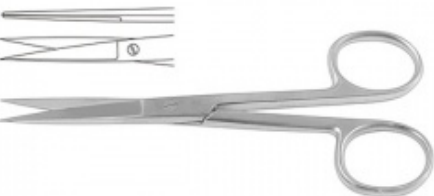
Operating Scissors

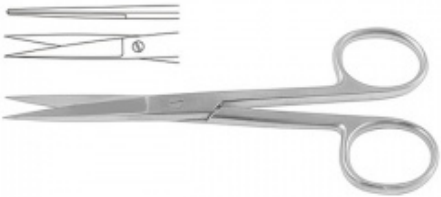

Product Image	Product Name	Price(\$)
	<p>Operating Scissors HIC-8636</p>	<p>0.00</p>

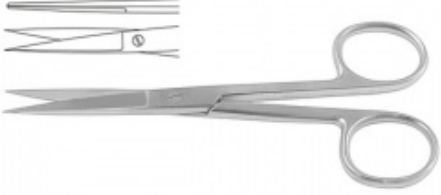
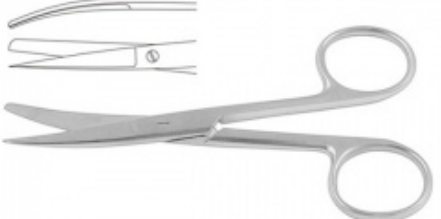

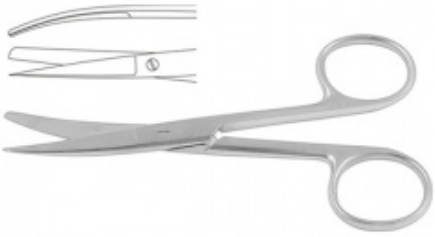
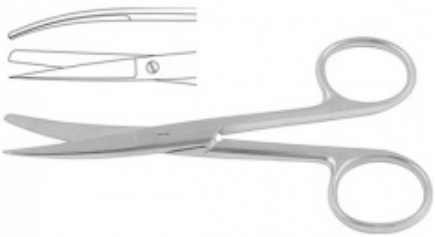
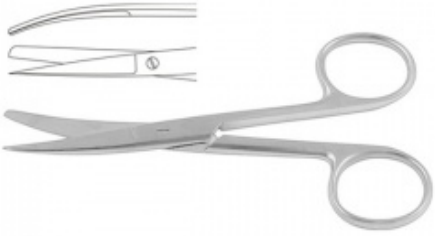
 <p>A pair of surgical operating scissors with long, straight blades and rounded handles. A small inset image in the top left corner shows a magnified view of the blade tip, which is finely serrated.</p>	<p>Operating Scissors HIC-8635</p>	<p>0.00</p>
 <p>A pair of surgical operating scissors with long, straight blades and rounded handles. A small inset image in the top left corner shows a magnified view of the blade tip, which is finely serrated.</p>	<p>Operating Scissors HIC-8634</p>	<p>0.00</p>
 <p>A pair of surgical operating scissors with long, straight blades and rounded handles. A small inset image in the top left corner shows a magnified view of the blade tip, which is finely serrated.</p>	<p>Operating Scissors HIC-8633</p>	<p>0.00</p>
 <p>A pair of surgical operating scissors with long, straight blades and rounded handles. A small inset image in the top left corner shows a magnified view of the blade tip, which is finely serrated.</p>	<p>Operating Scissors HIC-8632</p>	<p>0.00</p>

 A pair of surgical operating scissors with long, straight blades and rounded handles. A smaller inset image shows the tip of the blades.	Operating Scissors HIC-8631	0.00
 A pair of surgical operating scissors with long, straight blades and rounded handles. A smaller inset image shows the tip of the blades.	Operating Scissors HIC-8630	0.00
 A pair of surgical operating scissors with long, straight blades and rounded handles. A smaller inset image shows the tip of the blades.	Operating Scissors HIC-8629	0.00
 A pair of surgical operating scissors with long, straight blades and rounded handles. A smaller inset image shows the tip of the blades.	Operating Scissors HIC-8628	0.00

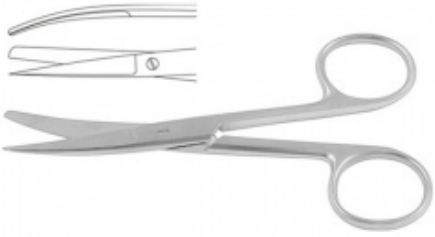
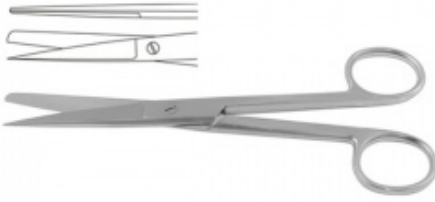
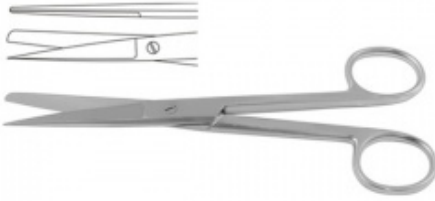
	<p>Operating Scissors HIC-8627</p>	<p>0.00</p>
	<p>Operating Scissors HIC-8626</p>	<p>0.00</p>
	<p>Operating Scissors HIC-8625</p>	<p>0.00</p>
	<p>Operating Scissors HIC-8624</p>	<p>0.00</p>

 A pair of surgical operating scissors with long handles and curved blades. A smaller inset image shows the scissors from a different perspective, highlighting the pivot point and the locking mechanism.	Operating Scissors HIC-8623	0.00
 A pair of surgical operating scissors with long handles and curved blades. A smaller inset image shows the scissors from a different perspective, highlighting the pivot point and the locking mechanism.	Operating Scissors HIC-8622	0.00
 A pair of surgical operating scissors with long handles and curved blades. A smaller inset image shows the scissors from a different perspective, highlighting the pivot point and the locking mechanism.	Operating Scissors HIC-8621	0.00
 A pair of surgical operating scissors with long handles and curved blades. A smaller inset image shows the scissors from a different perspective, highlighting the pivot point and the locking mechanism.	Operating Scissors HIC-8620	0.00

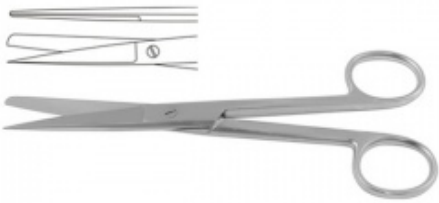
 A pair of surgical operating scissors with long handles and curved blades. A small inset image in the top left corner shows a different pair of surgical forceps.	Operating Scissors HIC-8619	0.00
 A pair of surgical operating scissors with long handles and curved blades. A small inset image in the top left corner shows a different pair of surgical forceps.	Operating Scissors HIC-8618	0.00
 A pair of surgical operating scissors with long handles and curved blades. A small inset image in the top left corner shows a different pair of surgical forceps.	Operating Scissors HIC-8617	0.00
 A pair of surgical operating scissors with long handles and curved blades. A small inset image in the top left corner shows a different pair of surgical forceps.	Operating Scissors HIC-8616	0.00

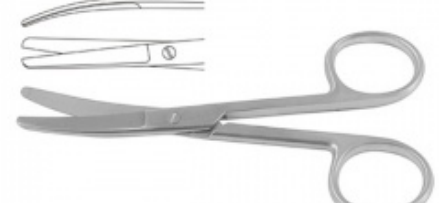
 <p>A pair of operating scissors with long handles and straight blades, shown in a 3D perspective view. A smaller 2D line drawing of the same scissors is positioned above the 3D model.</p>	<p>Operating Scissors HIC-8615</p>	<p>0.00</p>
 <p>A pair of operating scissors with long handles and straight blades, shown in a 3D perspective view. A smaller 2D line drawing of the same scissors is positioned above the 3D model.</p>	<p>Operating Scissors HIC-8614</p>	<p>0.00</p>
 <p>A pair of operating scissors with long handles and straight blades, shown in a 3D perspective view. A smaller 2D line drawing of the same scissors is positioned above the 3D model.</p>	<p>Operating Scissors HIC-8613</p>	<p>0.00</p>
 <p>A pair of operating scissors with long handles and straight blades, shown in a 3D perspective view. A smaller 2D line drawing of the same scissors is positioned above the 3D model.</p>	<p>Operating Scissors HIC-8612</p>	<p>0.00</p>

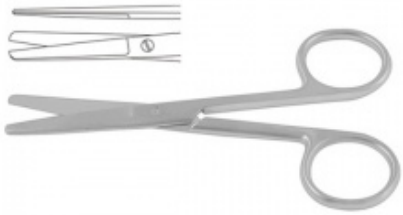
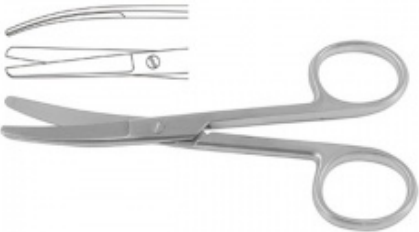
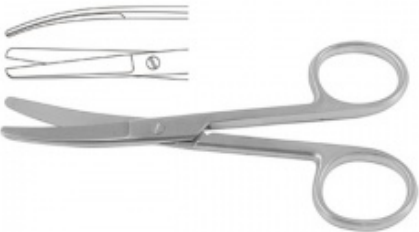

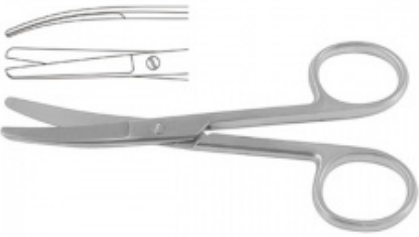
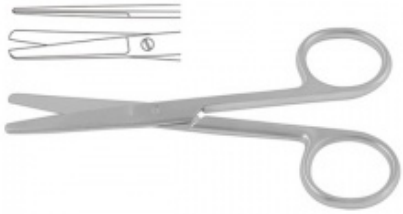
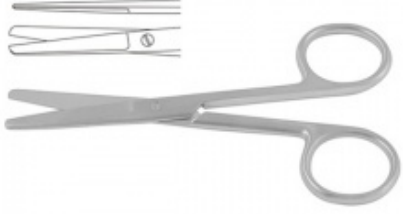
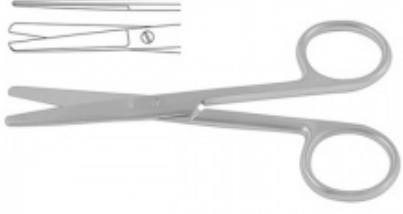
 A pair of operating scissors with long handles and curved blades. A smaller inset image shows the scissors from a different angle, highlighting the pivot point and the locking mechanism.	Operating Scissors HIC-8611	0.00
 A pair of operating scissors with long handles and curved blades. A smaller inset image shows the scissors from a different angle, highlighting the pivot point and the locking mechanism.	Operating Scissors HIC-8610	0.00
 A pair of operating scissors with long handles and curved blades. A smaller inset image shows the scissors from a different angle, highlighting the pivot point and the locking mechanism.	Operating Scissors HIC-8609	0.00
 A pair of operating scissors with long handles and curved blades. A smaller inset image shows the scissors from a different angle, highlighting the pivot point and the locking mechanism.	Operating Scissors HIC-8608	0.00

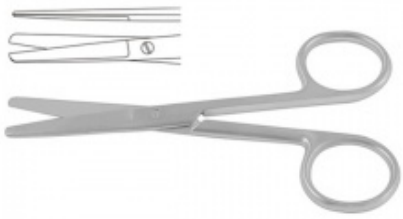
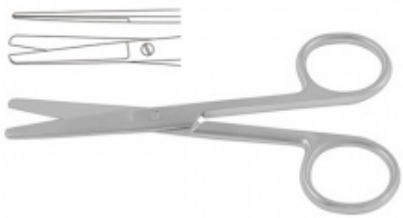
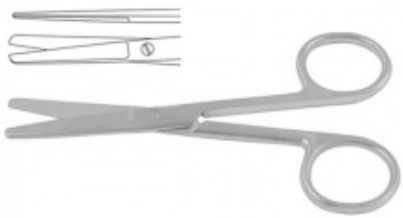
 A pair of surgical operating scissors with long handles and curved blades, shown in a closed position. A small inset image in the top left corner shows a different view of the same scissors.	Operating Scissors HIC-8607	0.00
 A pair of surgical operating scissors with long handles and curved blades, shown in a closed position. A small inset image in the top left corner shows a different view of the same scissors.	Operating Scissors HIC-8606	0.00
 A pair of surgical operating scissors with long handles and curved blades, shown in a closed position. A small inset image in the top left corner shows a different view of the same scissors.	Operating Scissors HIC-8605	0.00
 A pair of surgical operating scissors with long handles and curved blades, shown in a closed position. A small inset image in the top left corner shows a different view of the same scissors.	Operating Scissors HIC-8604	0.00

	<p>Operating Scissors HIC-8603</p>	<p>0.00</p>
	<p>Operating Scissors HIC-8602</p>	<p>0.00</p>
	<p>Operating Scissors HIC-8601</p>	<p>0.00</p>





Plaster Shears



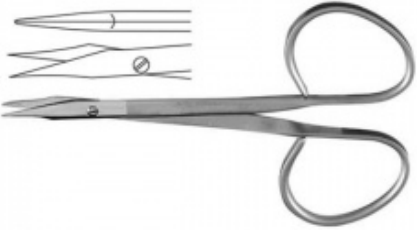

Product Image	Product Name	Price(\$)



	<p>Plaster Shears HIC-8703</p>	<p>0.00</p>
	<p>Plaster Shears HIC-8702</p>	<p>0.00</p>
	<p>Plaster Shears HIC-8701</p>	<p>0.00</p>

Ribbon Scissors



Product Image	Product Name	Price(\$)

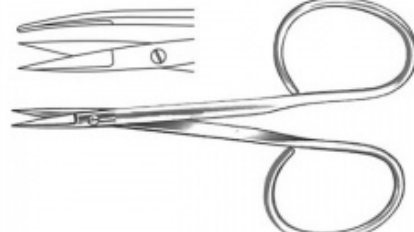

 An illustration of a pair of ribbon scissors. The blades are long and narrow with a pointed tip. The handles are curved and have a finger loop and a thumb loop. To the left of the scissors, there are several horizontal lines representing a cut piece of ribbon.	<p>Ribbon Scissors HIC-8812</p>	<p>0.00</p>
 An illustration of a pair of ribbon scissors. The blades are long and narrow with a pointed tip. The handles are curved and have a finger loop and a thumb loop. To the left of the scissors, there are several horizontal lines representing a cut piece of ribbon.	<p>Ribbon Scissors HIC-8811</p>	<p>0.00</p>
 An illustration of a pair of ribbon scissors. The blades are long and narrow with a pointed tip. The handles are curved and have a finger loop and a thumb loop. To the left of the scissors, there are several horizontal lines representing a cut piece of ribbon.	<p>Ribbon Scissors HIC-8810</p>	<p>0.00</p>
 An illustration of a pair of ribbon scissors. The blades are long and narrow with a pointed tip. The handles are curved and have a finger loop and a thumb loop. To the left of the scissors, there are several horizontal lines representing a cut piece of ribbon.	<p>Ribbon Scissors HIC-8809</p>	<p>0.00</p>

 A pair of long-handled ribbon scissors with a small inset image showing the sharp, pointed blades.	Ribbon Scissors HIC-8808	0.00
 A pair of long-handled ribbon scissors with a small inset image showing the blades with a slight curve.	Ribbon Scissors HIC-8807	0.00
 A pair of long-handled ribbon scissors with a small inset image showing the blades with a slight curve.	Ribbon Scissors HIC-8806	0.00
 A pair of long-handled ribbon scissors with a small inset image showing the blades with a slight curve.	Ribbon Scissors HIC-8805	0.00

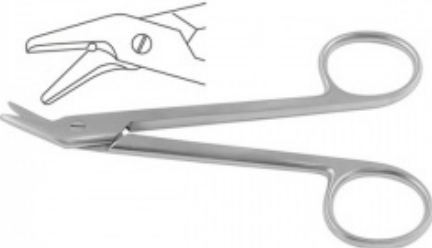
	<p>Ribbon Scissors HIC-8804</p>	<p>0.00</p>
	<p>Ribbon Scissors HIC-8803</p>	<p>0.00</p>
	<p>Ribbon Scissors HIC-8802</p>	<p>0.00</p>
	<p>Ribbon Scissors HIC-8801</p>	<p>0.00</p>

Stitch and Wire Cutting Scissors

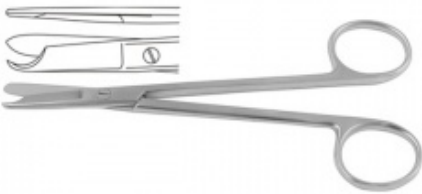
Product Image	Product Name	Price(\$)
 A pair of long-handled surgical scissors with straight blades. To the left of the scissors are three small inset images showing different views of the blade tips: a straight tip, a slightly curved tip, and a tip with a small notch.	Stitch and Wire Cutting Scissors HIC-8909	0.00
 A pair of long-handled surgical scissors with straight blades. To the left of the scissors is a single inset image showing a close-up of the blade tip with a small notch.	Stitch and Wire Cutting Scissors HIC-8908	0.00
 A pair of long-handled surgical scissors with straight blades. To the left of the scissors are three small inset images showing different views of the blade tips: a straight tip, a tip with a small notch, and a tip with a different notch design.	Stitch and Wire Cutting Scissors HIC-8907	0.00

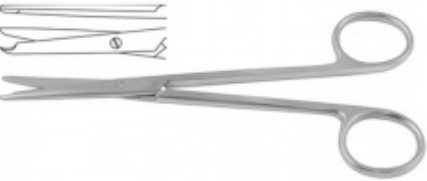
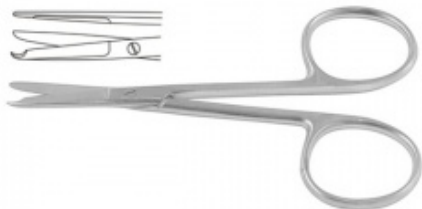
	<p>Stitch and Wire Cutting Scissors HIC-8906</p>	<p>0.00</p>
	<p>Stitch and Wire Cutting Scissors HIC-8905</p>	<p>0.00</p>
	<p>Stitch and Wire Cutting Scissors HIC-8904</p>	<p>0.00</p>
	<p>Stitch and Wire Cutting Scissors HIC-8903</p>	<p>0.00</p>

	<p>Stitch and Wire Cutting Scissors HIC-8902</p>	<p>0.00</p>
	<p>Stitch and Wire Cutting Scissors HIC-8901</p>	<p>0.00</p>





Strabismus Scissors





Product Image	Product Name	Price(\$)
	<p>Strabismus Scissors HIC-9003</p>	<p>0.00</p>





	<p>Strabismus Scissors HIC-9002</p>	<p>0.00</p>
	<p>Strabismus Scissors HIC-9001</p>	<p>0.00</p>





Super Cut Scissors

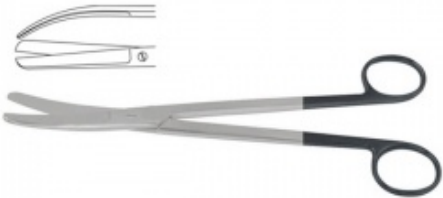



Product Image	Product Name	Price(\$)
	<p>Super Cut Scissors HIC-9126</p>	<p>0.00</p>



 <p>The illustration shows a pair of surgical scissors with long, straight blades and black handles. To the left of the main pair is a smaller, detailed view of the blade tip, showing a sharp, pointed edge and a small circular hole near the base of the blade.</p>	<p>Super Cut Scissors HIC-9127</p>	<p>0.00</p>
 <p>The illustration shows a pair of surgical scissors with long, straight blades and black handles. To the left of the main pair is a smaller, detailed view of the blade tip, showing a sharp, pointed edge and a small circular hole near the base of the blade.</p>	<p>Super Cut Scissors HIC-9125</p>	<p>0.00</p>
 <p>The illustration shows a pair of surgical scissors with long, straight blades and black handles. To the left of the main pair is a smaller, detailed view of the blade tip, showing a sharp, pointed edge and a small circular hole near the base of the blade.</p>	<p>Super Cut Scissors HIC-9123</p>	<p>0.00</p>
 <p>The illustration shows a pair of surgical scissors with long, straight blades and black handles. To the left of the main pair is a smaller, detailed view of the blade tip, showing a sharp, pointed edge and a small circular hole near the base of the blade.</p>	<p>Super Cut Scissors HIC-9124</p>	<p>0.00</p>

	<p>Super Cut Scissors HIC-9122</p>	<p>0.00</p>
	<p>Super Cut Scissors HIC-9120</p>	<p>0.00</p>
	<p>Super Cut Scissors HIC-9121</p>	<p>0.00</p>
	<p>Super Cut Scissors HIC-9119</p>	<p>0.00</p>

	<p>Super Cut Scissors HIC-9117</p>	<p>0.00</p>
	<p>Super Cut Scissors HIC-9118</p>	<p>0.00</p>
	<p>Super Cut Scissors HIC-9116</p>	<p>0.00</p>
	<p>Super Cut Scissors HIC-9115</p>	<p>0.00</p>

	<p>Super Cut Scissors HIC-9114</p>	<p>0.00</p>
	<p>Super Cut Scissors HIC-9113</p>	<p>0.00</p>
	<p>Super Cut Scissors HIC-9112</p>	<p>0.00</p>
	<p>Super Cut Scissors HIC-9111</p>	<p>0.00</p>

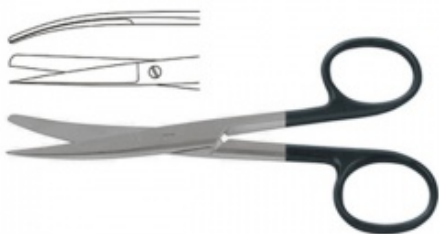

	<p>Super Cut Scissors HIC-9110</p>	<p>0.00</p>
	<p>Super Cut Scissors HIC-9109</p>	<p>0.00</p>
	<p>Super Cut Scissors HIC-9108</p>	<p>0.00</p>
	<p>Super Cut Scissors HIC-9107</p>	<p>0.00</p>

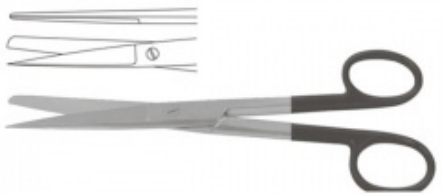



	<p>Super Cut Scissors HIC-9106</p>	<p>0.00</p>
	<p>Super Cut Scissors HIC-9105</p>	<p>0.00</p>
	<p>Super Cut Scissors HIC-9104</p>	<p>0.00</p>
	<p>Super Cut Scissors HIC-9103</p>	<p>0.00</p>

	<p>Super Cut Scissors HIC-9102</p>	<p>0.00</p>
	<p>Super Cut Scissors HIC-9101</p>	<p>0.00</p>

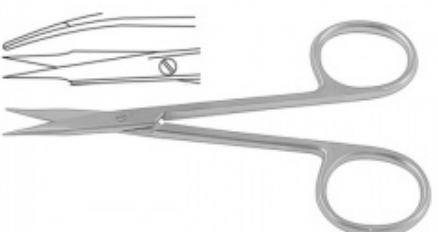

Tenotomy Scissors

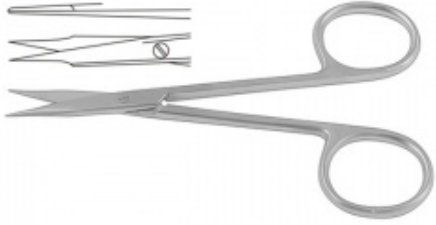
Product Image	Product Name	Price(\$)
	<p>Tenotomy Scissors HIC-9208</p>	<p>0.00</p>



 An illustration of a pair of tenotomy scissors. The blades are long and thin, with a small circular hole near the tip of the upper blade. The handles are curved and have a textured grip.	Tenotomy Scissors HIC-9209	0.00
 An illustration of a pair of tenotomy scissors, identical in design to the first row. The blades are long and thin, with a small circular hole near the tip of the upper blade. The handles are curved and have a textured grip.	Tenotomy Scissors HIC-9207	0.00
 An illustration of a pair of tenotomy scissors, identical in design to the previous rows. The blades are long and thin, with a small circular hole near the tip of the upper blade. The handles are curved and have a textured grip.	Tenotomy Scissors HIC-9205	0.00
 An illustration of a pair of tenotomy scissors, identical in design to the previous rows. The blades are long and thin, with a small circular hole near the tip of the upper blade. The handles are curved and have a textured grip.	Tenotomy Scissors HIC-9206	0.00

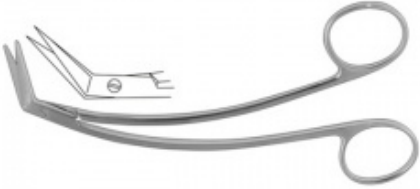

	Tenotomy Scissors HIC-9204	0.00
	Tenotomy Scissors HIC-9202	0.00
	Tenotomy Scissors HIC-9203	0.00
	Tenotomy Scissors HIC-9201	0.00

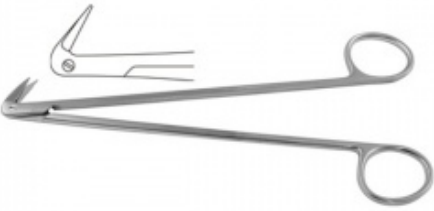
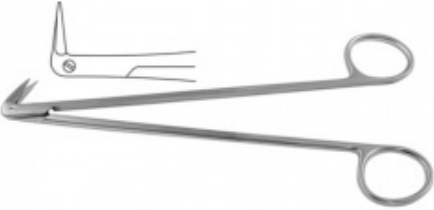
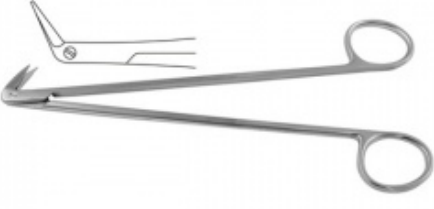
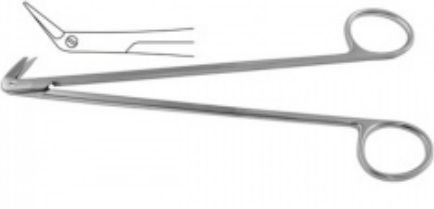

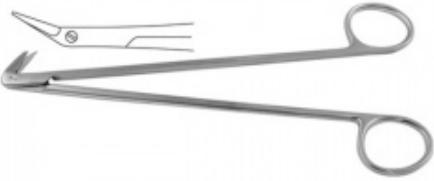
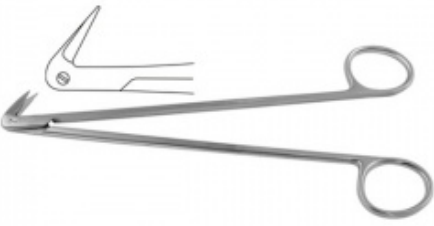

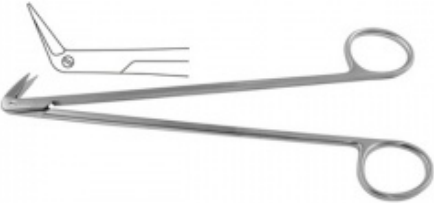
Thorax and Vascular Scissors

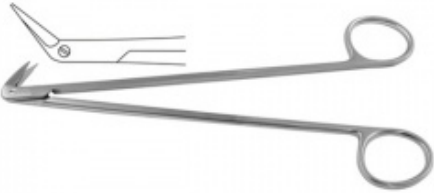

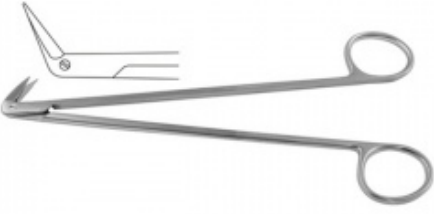

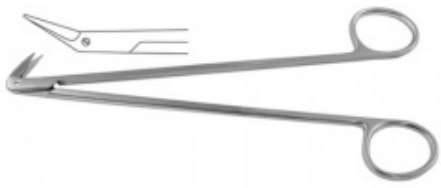
Product Image	Product Name	Price(\$)
 A pair of curved thorax and vascular scissors with long handles and a sharp, curved blade.	Thorax and Vascular Scissors HIC-9327	0.00
 A pair of curved thorax and vascular scissors with long handles and a sharp, curved blade, similar to HIC-9327 but with a slightly different blade curvature.	Thorax and Vascular Scissors HIC-9326	0.00
 A pair of straight thorax and vascular scissors with long handles and a sharp, straight blade.	Thorax and Vascular Scissors HIC-9325	0.00

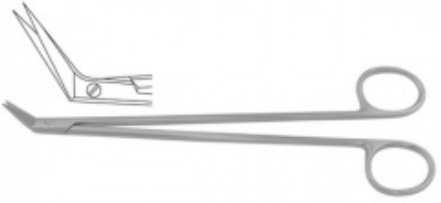
	Thorax and Vascular Scissors HIC-9324	0.00
	Thorax and Vascular Scissors HIC-9323	0.00
	Thorax and Vascular Scissors HIC-9322	0.00
	Thorax and Vascular Scissors HIC-9321	0.00

 A pair of long-handled surgical scissors with a curved blade and a small hook-like tip. A technical drawing of the blade tip is shown in the upper left corner of the illustration.	Thorax and Vascular Scissors HIC-9320	0.00
 A pair of long-handled surgical scissors with a curved blade and a small hook-like tip. A technical drawing of the blade tip is shown in the upper left corner of the illustration.	Thorax and Vascular Scissors HIC-9319	0.00
 A pair of long-handled surgical scissors with a curved blade and a small hook-like tip. A technical drawing of the blade tip is shown in the upper left corner of the illustration.	Thorax and Vascular Scissors HIC-9318	0.00
 A pair of long-handled surgical scissors with a curved blade and a small hook-like tip. A technical drawing of the blade tip is shown in the upper left corner of the illustration.	Thorax and Vascular Scissors HIC-9317	0.00

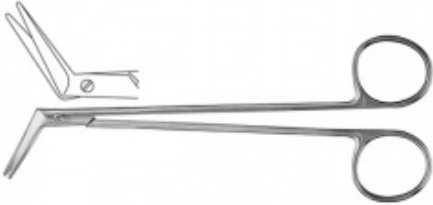

	<p>Thorax and Vascular Scissors HIC-9316</p>	<p>0.00</p>
	<p>Thorax and Vascular Scissors HIC-9315</p>	<p>0.00</p>
	<p>Thorax and Vascular Scissors HIC-9314</p>	<p>0.00</p>
	<p>Thorax and Vascular Scissors HIC-9313</p>	<p>0.00</p>

 A pair of long-handled surgical scissors with a curved blade and a locking mechanism.	Thorax and Vascular Scissors HIC-9312	0.00
 A pair of long-handled surgical scissors with a curved blade.	Thorax and Vascular Scissors HIC-9311	0.00
 A pair of long-handled surgical scissors with a curved blade and a locking mechanism.	Thorax and Vascular Scissors HIC-9310	0.00
 A pair of long-handled surgical scissors with a curved blade and a locking mechanism.	Thorax and Vascular Scissors HIC-9309	0.00

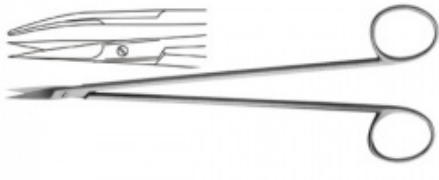
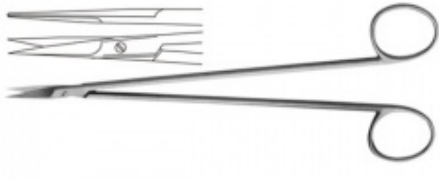
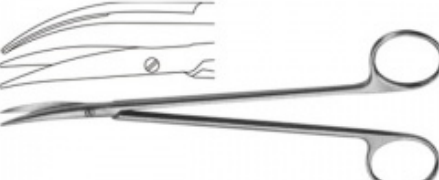
	<p>Thorax and Vascular Scissors HIC-9308</p>	<p>0.00</p>
	<p>Thorax and Vascular Scissors HIC-9307</p>	<p>0.00</p>
	<p>Thorax and Vascular Scissors HIC-9306</p>	<p>0.00</p>
	<p>Thorax and Vascular Scissors HIC-9305</p>	<p>0.00</p>

	<p>Thorax and Vascular Scissors HIC-9304</p>	<p>0.00</p>
	<p>Thorax and Vascular Scissors HIC-9303</p>	<p>0.00</p>
	<p>Thorax and Vascular Scissors HIC-9302</p>	<p>0.00</p>
	<p>Thorax and Vascular Scissors HIC-9301</p>	<p>0.00</p>

Tonsil Scissors

Product Image	Product Name	Price(\$)
 A pair of long-handled tonsil scissors with a curved blade and a small hook-like tip. A smaller pair of similar scissors is shown above it for comparison.	Tonsil Scissors HIC-9404	0.00
 A pair of long-handled tonsil scissors with a curved blade and a small hook-like tip. A smaller pair of similar scissors is shown above it for comparison.	Tonsil Scissors HIC-9403	0.00
 A pair of long-handled tonsil scissors with a curved blade and a small hook-like tip. A smaller pair of similar scissors is shown above it for comparison.	Tonsil Scissors HIC-9402	0.00

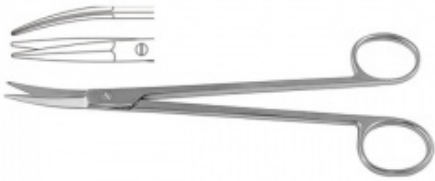
	<p>Tonsil Scissors HIC-9401</p>	<p>0.00</p>
---	-------------------------------------	-------------

Umbilical Scissors

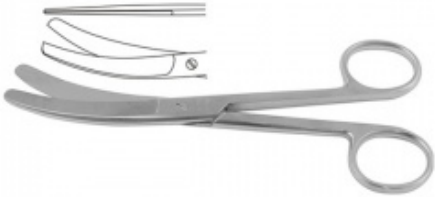
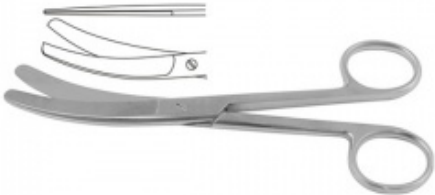

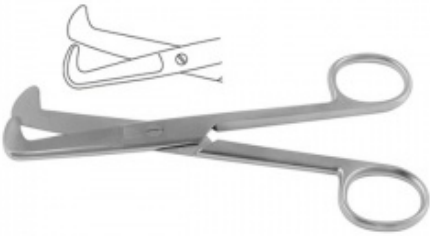
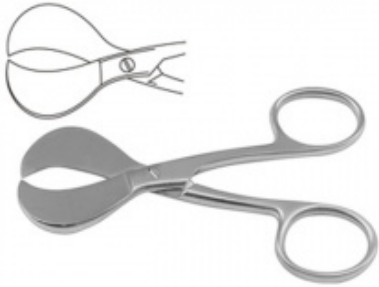

Product Image	Product Name	Price(\$)
	<p>Umbilical Scissors HIC-9504</p>	<p>0.00</p>
	<p>Umbilical Scissors HIC-9503</p>	<p>0.00</p>





	<p>Umbilical Scissors HIC-9502</p>	<p>0.00</p>
	<p>Umbilical Scissors HIC-9501</p>	<p>0.00</p>





SPONGE FORCEPS



Dressing Forceps





Product Image	Product Name	Price(\$)
	<p>Dressing Forceps HIC-9624</p>	<p>0.00</p>

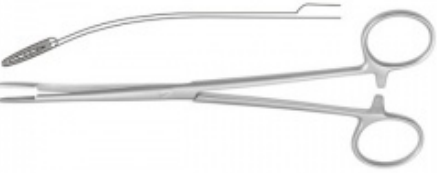

 <p>The illustration shows a pair of long-handled dressing forceps with curved tips. A separate detail of the handle is shown above the main pair, featuring a textured grip section.</p>	<p>Dressing Forceps HIC-9623</p>	<p>0.00</p>
 <p>The illustration shows a pair of long-handled dressing forceps with curved tips. A separate detail of the handle is shown above the main pair, featuring a textured grip section.</p>	<p>Dressing Forceps HIC-9622</p>	<p>0.00</p>
 <p>The illustration shows a pair of long-handled dressing forceps with curved tips. A separate detail of the handle is shown above the main pair, featuring a textured grip section.</p>	<p>Dressing Forceps HIC-9621</p>	<p>0.00</p>
 <p>The illustration shows a pair of long-handled dressing forceps with curved tips. A separate detail of the handle is shown above the main pair, featuring a textured grip section.</p>	<p>Dressing Forceps HIC-9620</p>	<p>0.00</p>

	<p>Dressing Forceps HIC-9619</p>	<p>0.00</p>
	<p>Dressing Forceps HIC-9618</p>	<p>0.00</p>
	<p>Dressing Forceps HIC-9617</p>	<p>0.00</p>
	<p>Dressing Forceps HIC-9616</p>	<p>0.00</p>

 <p>The illustration shows a pair of long-handled dressing forceps with curved tips and a serrated thumb hole. A separate detail of the serrated thumb hole is shown above the main pair of forceps.</p>	<p>Dressing Forceps HIC-9615</p>	<p>0.00</p>
 <p>The illustration shows a pair of long-handled dressing forceps with curved tips and a serrated thumb hole. A separate detail of the serrated thumb hole is shown above the main pair of forceps.</p>	<p>Dressing Forceps HIC-9614</p>	<p>0.00</p>
 <p>The illustration shows a pair of long-handled dressing forceps with curved tips and a serrated thumb hole. A separate detail of the serrated thumb hole is shown above the main pair of forceps.</p>	<p>Dressing Forceps HIC-9613</p>	<p>0.00</p>
 <p>The illustration shows a pair of long-handled dressing forceps with curved tips and a serrated thumb hole. A separate detail of the serrated thumb hole is shown above the main pair of forceps.</p>	<p>Dressing Forceps HIC-9612</p>	<p>0.00</p>



	<p>Dressing Forceps HIC-9611</p>	<p>0.00</p>
	<p>Dressing Forceps HIC-9610</p>	<p>0.00</p>
	<p>Dressing Forceps HIC-9609</p>	<p>0.00</p>
	<p>Dressing Forceps HIC-9607</p>	<p>0.00</p>

	<p>Dressing Forceps HIC-9608</p>	<p>0.00</p>
	<p>Dressing Forceps HIC-9606</p>	<p>0.00</p>
	<p>Dressing Forceps HIC-9605</p>	<p>0.00</p>
	<p>Dressing Forceps HIC-9604</p>	<p>0.00</p>

	<p>Dressing Forceps HIC-9602</p>	<p>0.00</p>
	<p>Dressing Forceps HIC-9601</p>	<p>0.00</p>

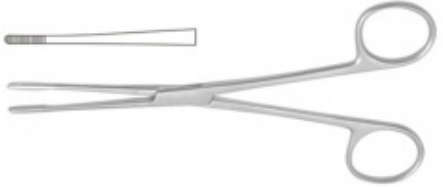

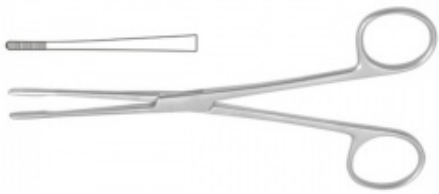
Sinus Forceps





Product Image	Product Name	Price(\$)
	<p>Sinus Forceps HIC-9703</p>	<p>0.00</p>

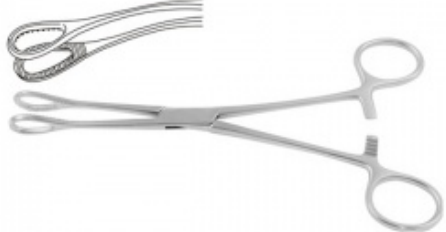

	<p>Sinus Forceps HIC-9702</p>	<p>0.00</p>
	<p>Sinus Forceps HIC-9701</p>	<p>0.00</p>



Sponge Holding Forceps

Product Image	Product Name	Price(\$)
	<p>Sponge Holding Forceps HIC-9818</p>	<p>0.00</p>

	<p>Sponge Holding Forceps HIC-9817</p>	<p>0.00</p>
	<p>Sponge Holding Forceps HIC-9816</p>	<p>0.00</p>
	<p>Sponge Holding Forceps HIC-9815</p>	<p>0.00</p>
	<p>Sponge Holding Forceps HIC-9814</p>	<p>0.00</p>

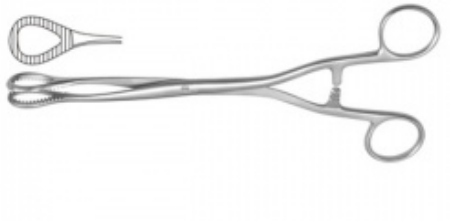
 A pair of surgical sponge holding forceps with long, thin jaws and a locking mechanism. The handles are curved and have finger loops. A smaller pair of similar forceps is shown in the background.	Sponge Holding Forceps HIC-9813	0.00
 A pair of surgical sponge holding forceps with long, thin jaws and a locking mechanism. The handles are curved and have finger loops. A smaller pair of similar forceps is shown in the background.	Sponge Holding Forceps HIC-9812	0.00
 A pair of surgical sponge holding forceps with long, thin jaws and a locking mechanism. The handles are curved and have finger loops. A smaller pair of similar forceps is shown in the background.	Sponge Holding Forceps HIC-9811	0.00
 A pair of surgical sponge holding forceps with long, thin jaws and a locking mechanism. The handles are curved and have finger loops. A smaller pair of similar forceps is shown in the background.	Sponge Holding Forceps HIC-9810	0.00

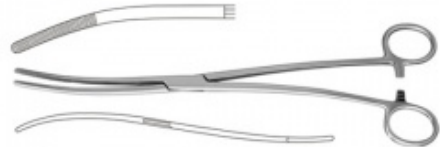
	<p>Sponge Holding Forceps HIC-9809</p>	<p>0.00</p>
	<p>Sponge Holding Forceps HIC-9808</p>	<p>0.00</p>
	<p>Sponge Holding Forceps HIC-9807</p>	<p>0.00</p>
	<p>Sponge Holding Forceps HIC-9806</p>	<p>0.00</p>





	<p>Sponge Holding Forceps HIC-9805</p>	<p>0.00</p>
	<p>Sponge Holding Forceps HIC-9804</p>	<p>0.00</p>
	<p>Sponge Holding Forceps HIC-9803</p>	<p>0.00</p>
	<p>Sponge Holding Forceps HIC-9802</p>	<p>0.00</p>

	<p>Sponge Holding Forceps HIC-9801</p>	<p>0.00</p>
---	--	-------------

SUTURE INSTRUMENTS

Ligature Clips and Applying Forceps





Product Image	Product Name	Price(\$)
	<p>Ligature Clips and Applying Forceps HIC-9906</p>	<p>0.00</p>
	<p>Ligature Clips and Applying Forceps HIC-9905</p>	<p>0.00</p>

 A pair of surgical forceps with long, tapered jaws and a serrated inner surface on the lower jaw. The handles are long and straight.	<p>Ligature Clips and Applying Forceps HIC-9904</p>	<p>0.00</p>
 A pair of surgical forceps with long, tapered jaws and a serrated inner surface on the lower jaw. The handles are long and straight.	<p>Ligature Clips and Applying Forceps HIC-9903</p>	<p>0.00</p>
 A pair of surgical forceps with long, tapered jaws and a serrated inner surface on the lower jaw. The handles are long and straight.	<p>Ligature Clips and Applying Forceps HIC-9902</p>	<p>0.00</p>
 A pair of surgical forceps with long, tapered jaws and a serrated inner surface on the lower jaw. The handles are long and straight.	<p>Ligature Clips and Applying Forceps HIC-9901</p>	<p>0.00</p>

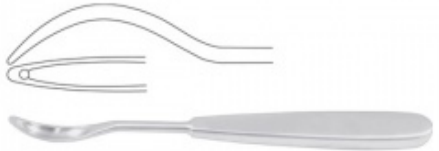

Ligature Conductors

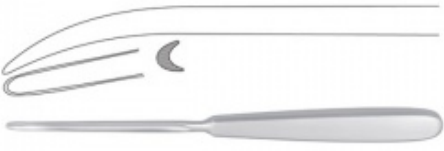

Product Image	Product Name	Price(\$)
	Ligature Conductors HIC-10010	0.00
	Ligature Conductors HIC-10009	0.00
	Ligature Conductors HIC-10008	0.00

	<p>Ligature Conductors HIC-10007</p>	<p>0.00</p>
	<p>Ligature Conductors HIC-10007</p>	<p>0.00</p>
	<p>Ligature Conductors HIC-10006</p>	<p>0.00</p>
	<p>Ligature Conductors HIC-10005</p>	<p>0.00</p>

	<p>Ligature Conductors HIC-10004</p>	<p>0.00</p>
	<p>Ligature Conductors HIC-10003</p>	<p>0.00</p>
	<p>Ligature Conductors HIC-10002</p>	<p>0.00</p>
	<p>Ligature Conductors HIC-10001</p>	<p>0.00</p>





Ligature Instruments



Product Image	Product Name	Price(\$)
 A long, thin, silver-colored metal instrument with a slightly curved tip, likely a ligature instrument.	Ligature Instruments HIC-11005	0.00
 A long, thin, silver-colored metal instrument with a straight tip, likely a ligature instrument.	Ligature Instruments HIC-11004	0.00
 A long, thin, silver-colored metal instrument with a slightly curved tip, likely a ligature instrument.	Ligature Instruments HIC-11003	0.00



	<p>Ligature Instruments HIC-11002</p>	<p>0.00</p>
	<p>Ligature Instruments HIC-11001</p>	<p>0.00</p>



Ligature Needles



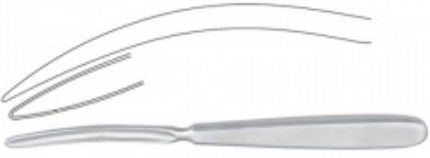
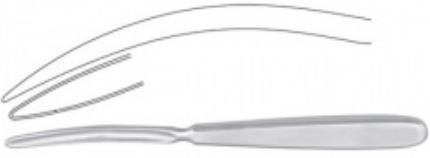

Product Image	Product Name	Price(\$)
	<p>Ligature Needles HIC-12027</p>	<p>0.00</p>

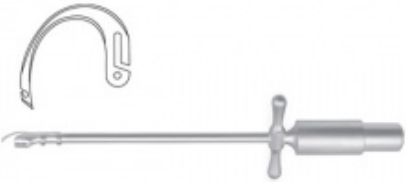



	<p>Ligature Needles HIC-12026</p>	<p>0.00</p>
	<p>Ligature Needles HIC-12025</p>	<p>0.00</p>
	<p>Ligature Needles HIC-12024</p>	<p>0.00</p>
	<p>Ligature Needles HIC-12023</p>	<p>0.00</p>

	<p>Ligature Needles HIC-12022</p>	<p>0.00</p>
	<p>Ligature Needles HIC-12021</p>	<p>0.00</p>
	<p>Ligature Needles HIC-12020</p>	<p>0.00</p>
	<p>Ligature Needles HIC-12019</p>	<p>0.00</p>

	<p>Ligature Needles HIC-12018</p>	<p>0.00</p>
	<p>Ligature Needles HIC-12017</p>	<p>0.00</p>
	<p>Ligature Needles HIC-12016</p>	<p>0.00</p>
	<p>Ligature Needles HIC-12015</p>	<p>0.00</p>

	<p>Ligature Needles HIC-12014</p>	<p>0.00</p>
	<p>Ligature Needles HIC-12013</p>	<p>0.00</p>
	<p>Ligature Needles HIC-12012</p>	<p>0.00</p>
	<p>Ligature Needles HIC-12011</p>	<p>0.00</p>





	<p>Ligature Needles HIC-12010</p>	<p>0.00</p>
	<p>Ligature Needles HIC-12009</p>	<p>0.00</p>
	<p>Ligature Needles HIC-12008</p>	<p>0.00</p>
	<p>Ligature Needles HIC-12007</p>	<p>0.00</p>





	<p>Ligature Needles HIC-12006</p>	<p>0.00</p>
	<p>Ligature Needles HIC-12005</p>	<p>0.00</p>
	<p>Ligature Needles HIC-12004</p>	<p>0.00</p>
	<p>Ligature Needles HIC-12003</p>	<p>0.00</p>





	<p>Ligature Needles HIC-12002</p>	<p>0.00</p>
	<p>Ligature Needles HIC-12001</p>	<p>0.00</p>





Micro Needle Holders





Product Image	Product Name	Price(\$)
	<p>Micro Needle Holders HIC-13021</p>	<p>0.00</p>

 A pair of stainless steel micro needle holders with a curved, beak-like tip and a textured grip on the handle.	<p>Micro Needle Holders HIC-13020</p>	<p>0.00</p>
 A pair of stainless steel micro needle holders with a curved, beak-like tip and a textured grip on the handle, featuring a central pivot point.	<p>Micro Needle Holders HIC-13019</p>	<p>0.00</p>
 A pair of stainless steel micro needle holders with a curved, beak-like tip and a textured grip on the handle, featuring a central pivot point.	<p>Micro Needle Holders HIC-13018</p>	<p>0.00</p>
 A pair of stainless steel micro needle holders with a curved, beak-like tip and a textured grip on the handle, featuring a central pivot point.	<p>Micro Needle Holders HIC-13017</p>	<p>0.00</p>

 A pair of micro needle holders with long, thin jaws and a curved handle with three finger loops.	<p>Micro Needle Holders HIC-13016</p>	<p>0.00</p>
 A pair of micro needle holders with long, thin jaws and a curved handle with two finger loops and a thumb loop.	<p>Micro Needle Holders HIC-13015</p>	<p>0.00</p>
 A pair of micro needle holders with long, thin jaws and a curved handle with two finger loops and a thumb loop.	<p>Micro Needle Holders HIC-14014</p>	<p>0.00</p>
 A pair of micro needle holders with long, thin jaws and a curved handle with two finger loops and a thumb loop.	<p>Micro Needle Holders HIC-13014</p>	<p>0.00</p>



 A pair of micro needle holders with a textured grip and a small hook on the left side.	<p>Micro Needle Holders HIC-13013</p>	<p>0.00</p>
 A pair of micro needle holders with a textured grip and a small hook on the left side.	<p>Micro Needle Holders HIC-13012</p>	<p>0.00</p>
 A pair of micro needle holders with a textured grip and a small hook on the left side.	<p>Micro Needle Holders HIC-13011</p>	<p>0.00</p>
 A pair of micro needle holders with a textured grip and a small hook on the left side.	<p>Micro Needle Holders HIC-13010</p>	<p>0.00</p>





 A pair of micro needle holders with a curved, beak-like tip and a textured grip area in the middle of the handle.	<p>Micro Needle Holders HIC-13009</p>	<p>0.00</p>
 A pair of micro needle holders with a curved, beak-like tip and a textured grip area in the middle of the handle.	<p>Micro Needle Holders HIC-13008</p>	<p>0.00</p>
 A pair of micro needle holders with a curved, beak-like tip and a textured grip area in the middle of the handle.	<p>Micro Needle Holders HIC-13007</p>	<p>0.00</p>
 A pair of micro needle holders with a curved, beak-like tip and a textured grip area in the middle of the handle.	<p>Micro Needle Holders HIC-13006</p>	<p>0.00</p>



 A pair of micro needle holders with a curved, beak-like tip and a small hook on the left handle.	<p>Micro Needle Holders HIC-13005</p>	<p>0.00</p>
 A pair of micro needle holders with a curved, beak-like tip and a small hook on the left handle.	<p>Micro Needle Holders HIC-13004</p>	<p>0.00</p>
 A pair of micro needle holders with a curved, beak-like tip and a small hook on the left handle.	<p>Micro Needle Holders HIC-13003</p>	<p>0.00</p>
 A pair of micro needle holders with a curved, beak-like tip and a small hook on the left handle.	<p>Micro Needle Holders HIC-13002</p>	<p>0.00</p>





	<p>Micro Needle Holders HIC-13001</p>	<p>0.00</p>
---	---	-------------



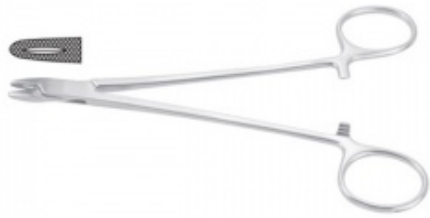

Needle Holders





Product Image	Product Name	Price(\$)
	<p>Needle Holders HIC-14027</p>	<p>0.00</p>
	<p>Needle Holders HIC-14026</p>	<p>0.00</p>





 A pair of surgical needle holders with long, tapered jaws and two circular handles. A small, rectangular, textured object is shown above the jaws.	Needle Holders HIC-14025	0.00
 A pair of surgical needle holders with long, tapered jaws and two circular handles. A small, rectangular, textured object is shown above the jaws.	Needle Holders HIC-14024	0.00
 A pair of surgical needle holders with long, tapered jaws and two circular handles. A small, rectangular, textured object is shown above the jaws.	Needle Holders HIC-14023	0.00
 A pair of surgical needle holders with long, tapered jaws and two circular handles. A small, rectangular, textured object is shown above the jaws.	Needle Holders HIC-14022	0.00

	<p>Needle Holders HIC-14021</p>	<p>0.00</p>
	<p>Needle Holders HIC-14020</p>	<p>0.00</p>
	<p>Needle Holders HIC-14019</p>	<p>0.00</p>
	<p>Needle Holders HIC-14018</p>	<p>0.00</p>

	<p>Needle Holders HIC-14017</p>	<p>0.00</p>
	<p>Needle Holders HIC-14016</p>	<p>0.00</p>
	<p>Needle Holders HIC-14015</p>	<p>0.00</p>
	<p>Needle Holders HIC-14014</p>	<p>0.00</p>



	<p>Needle Holders HIC-14013</p>	<p>0.00</p>
	<p>Needle Holders HIC-14012</p>	<p>0.00</p>
	<p>Needle Holders HIC-14011</p>	<p>0.00</p>
	<p>Needle Holders HIC-14010</p>	<p>0.00</p>

	<p>Needle Holders HIC-14009</p>	<p>0.00</p>
	<p>Needle Holders HIC-14008</p>	<p>0.00</p>
	<p>Needle Holders HIC-14007</p>	<p>0.00</p>
	<p>Needle Holders HIC-14006</p>	<p>0.00</p>



	<p>Needle Holders HIC-14005</p>	<p>0.00</p>
	<p>Needle Holders HIC-14004</p>	<p>0.00</p>
	<p>Needle Holders HIC-14003</p>	<p>0.00</p>
	<p>Needle Holders HIC-14002</p>	<p>0.00</p>

	<p style="text-align: center;">Needle Holders HIC-14001</p>	<p style="text-align: center;">0.00</p>
---	---	---

Tungsten Carbide Micro Needle Holders

Product Image	Product Name	Price(\$)
	<p style="text-align: center;">Tungsten Carbide Micro Needle Holders HIC-15015</p>	<p style="text-align: center;">0.00</p>
	<p style="text-align: center;">Tungsten Carbide Micro Needle Holders HIC-15014</p>	<p style="text-align: center;">0.00</p>

	<p>Tungsten Carbide Micro Needle Holders HIC-15013</p>	<p>0.00</p>
	<p>Tungsten Carbide Micro Needle Holders HIC-15012</p>	<p>0.00</p>
	<p>Tungsten Carbide Micro Needle Holders HIC-15011</p>	<p>0.00</p>
	<p>Tungsten Carbide Micro Needle Holders HIC-15010</p>	<p>0.00</p>



	<p>Tungsten Carbide Micro Needle Holders HIC-15009</p>	<p>0.00</p>
	<p>Tungsten Carbide Micro Needle Holders HIC-15008</p>	<p>0.00</p>
	<p>Tungsten Carbide Micro Needle Holders HIC-15007</p>	<p>0.00</p>
	<p>Tungsten Carbide Micro Needle Holders HIC-15006</p>	<p>0.00</p>



	<p>Tungsten Carbide Micro Needle Holders HIC-15005</p>	<p>0.00</p>
	<p>Tungsten Carbide Micro Needle Holders HIC-15004</p>	<p>0.00</p>
	<p>Tungsten Carbide Micro Needle Holders HIC-15002</p>	<p>0.00</p>
	<p>Tungsten Carbide Micro Needle Holders HIC-15003</p>	<p>0.00</p>





	<p>Tungsten Carbide Micro Needle Holders HIC-15001</p>	<p>0.00</p>
---	--	-------------

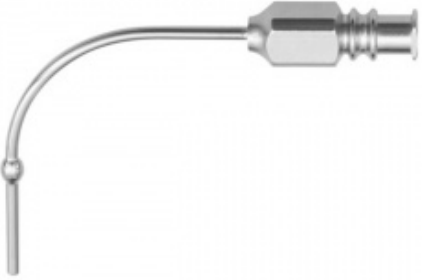
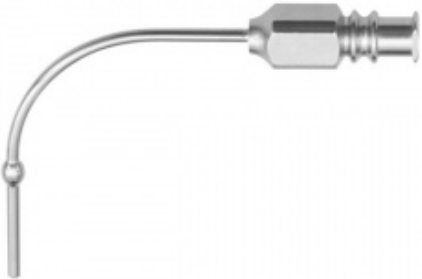

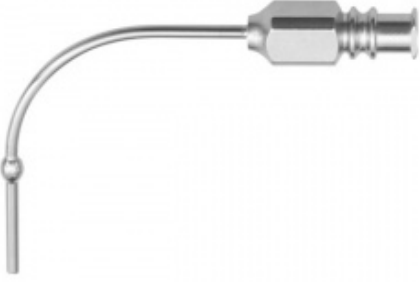

TROCARS, SUCTION TUBES AND CANNULAS





Cannulas

Product Image	Product Name	Price(\$)
	<p>Cannulas HIC-16018</p>	<p>0.00</p>
	<p>Cannulas HIC-16017</p>	<p>0.00</p>



 A straight metal cannula with a long, thin shaft and a small, rounded tip. A separate, shorter straight shaft is shown above it for comparison.	Cannulas HIC-16016	0.00
 A curved metal cannula with a long, thin shaft that bends at a 90-degree angle. It has a hexagonal connector at the base.	Cannulas HIC-16015	0.00
 A curved metal cannula with a long, thin shaft that bends at a 90-degree angle. It has a hexagonal connector at the base.	Cannulas HIC-14014	0.00
 A curved metal cannula with a long, thin shaft that bends at a 90-degree angle. It has a hexagonal connector at the base.	Cannulas HIC-16013	0.00





 A curved cannula with a long, thin shaft that bends at a 90-degree angle. The handle is a hexagonal, knurled metal piece with a threaded section at the end.	Cannulas HIC-16012	0.00
 A curved cannula with a long, thin shaft that bends at a 90-degree angle. The handle is a hexagonal, knurled metal piece with a threaded section at the end.	Cannulas HIC-16011	0.00
 A straight cannula with a long, thin shaft. The handle is a cylindrical metal piece with a threaded section and a small circular knob on the side.	Cannulas HIC-16010	0.00
 A straight cannula with a long, thin shaft. The handle is a cylindrical metal piece with a threaded section and a small circular knob on the side.	Cannulas HIC-16009	0.00





	<p>Cannulas HIC-16008</p>	<p>0.00</p>
	<p>Cannulas HIC-16007</p>	<p>0.00</p>
	<p>Cannulas HIC-16006</p>	<p>0.00</p>
	<p>Cannulas HIC-16005</p>	<p>0.00</p>





 A long, thin, curved cannula with a standard Luer-lock connector at the end.	Cannulas HIC-16004	0.00
 A long, thin, curved cannula with a standard Luer-lock connector at the end.	Cannulas HIC-16003	0.00
 A long, thin, curved cannula with a standard Luer-lock connector at the end.	Cannulas HIC-16002	0.00
 A short, wide cannula with a standard Luer-lock connector at one end and a tapered tip at the other.	Cannulas HIC-16001	0.00



Guide Needles

Product Image	Product Name	Price(\$)
	Guide Needles HIC-17018	0.00
	Guide Needles HIC-17017	0.00
	Guide Needles HIC-17015	0.00

	<p>Guide Needles HIC-17016</p>	<p>0.00</p>
	<p>Guide Needles HIC-17014</p>	<p>0.00</p>
	<p>Guide Needles HIC-17013</p>	<p>0.00</p>
	<p>Guide Needles HIC-17011</p>	<p>0.00</p>

	Guide Needles HIC-17012	0.00
	Guide Needles HIC-17010	0.00
	Guide Needles HIC-17009	0.00
	Guide Needles HIC-17007	0.00





	<p>Guide Needles HIC-17008</p>	<p>0.00</p>
	<p>Guide Needles HIC-17006</p>	<p>0.00</p>
	<p>Guide Needles HIC-17005</p>	<p>0.00</p>
	<p>Guide Needles HIC-17004</p>	<p>0.00</p>

	<p>Guide Needles HIC-17003</p>	<p>0.00</p>
	<p>Guide Needles HIC-17002</p>	<p>0.00</p>
	<p>Guide Needles HIC-17001</p>	<p>0.00</p>

Hypodermic Needles



Product Image	Product Name	Price(\$)





 A long, thin hypodermic needle with a circular ring at the base of the handle.	<p>Hypodermic Needles HIC-18009</p>	<p>0.00</p>
 A long, thin hypodermic needle with a standard Luer-lock connector at the base.	<p>Hypodermic Needles HIC-18008</p>	<p>0.00</p>
 A long, thin hypodermic needle with a standard Luer-lock connector at the base.	<p>Hypodermic Needles HIC-18007</p>	<p>0.00</p>
 A long, thin hypodermic needle with a standard Luer-lock connector at the base.	<p>Hypodermic Needles HIC-18006</p>	<p>0.00</p>

	<p>Hypodermic Needles HIC-18005</p>	<p>0.00</p>
	<p>Hypodermic Needles HIC-18004</p>	<p>0.00</p>
	<p>Hypodermic Needles HIC-18003</p>	<p>0.00</p>
	<p>Hypodermic Needles HIC-18002</p>	<p>0.00</p>



	<p>Hypodermic Needles HIC-18001</p>	<p>0.00</p>
---	---	-------------

Hypodermic Syringes





Product Image	Product Name	Price(\$)
	<p>Hypodermic Syringes HIC-19006</p>	<p>0.00</p>
	<p>Hypodermic Syringes HIC-19005</p>	<p>0.00</p>





	<p>Hypodermic Syringes HIC-19004</p>	<p>0.00</p>
	<p>Hypodermic Syringes HIC-19003</p>	<p>0.00</p>
	<p>Hypodermic Syringes HIC-19003</p>	<p>0.00</p>
	<p>Hypodermic Syringes HIC-19001</p>	<p>0.00</p>



Puncture Needles

Product Image	Product Name	Price(\$)
	Puncture Needles HIC-20018	0.00
	Puncture Needles HIC-20017	0.00
	Puncture Needles HIC-20016	0.00

	Puncture Needles HIC-20015	0.00
	Puncture Needles HIC-20014	0.00
	Puncture Needles HIC-20013	0.00
	Puncture Needles HIC-20012	0.00

	Puncture Needles HIC-20011	0.00
	Puncture Needles HIC-20010	0.00
	Puncture Needles HIC-20009	0.00
	Puncture Needles HIC-20008	0.00





	Puncture Needles HIC-20007	0.00
	Puncture Needles HIC-20006	0.00
	Puncture Needles HIC-20005	0.00
	Puncture Needles HIC-20004	0.00





	<p>Puncture Needles HIC-20003</p>	<p>0.00</p>
	<p>Puncture Needles HIC-20002</p>	<p>0.00</p>
	<p>Puncture Needles HIC-20001</p>	<p>0.00</p>





Suction Tubes





Product Image	Product Name	Price(\$)





 A stainless steel suction tube with a long, thin, curved tip and a threaded, cylindrical base.	Suction Tubes HIC-21024	0.00
 A stainless steel suction tube with a long, thin, curved tip and a threaded, cylindrical base.	Suction Tubes HIC-21023	0.00
 A stainless steel suction tube with a long, thin, curved tip and a threaded, cylindrical base.	Suction Tubes HIC-21022	0.00
 A stainless steel suction tube with a long, thin, curved tip and a threaded, cylindrical base.	Suction Tubes HIC-21021	0.00

	<p>Suction Tubes HIC-21020</p>	<p>0.00</p>
	<p>Suction Tubes HIC-21019</p>	<p>0.00</p>
	<p>Suction Tubes HIC-21018</p>	<p>0.00</p>
	<p>Suction Tubes HIC-21017</p>	<p>0.00</p>



 A metal suction tube with a 90-degree bend and a threaded end.	Suction Tubes HIC-21016	0.00
 A metal suction tube with a 90-degree bend and a threaded end.	Suction Tubes HIC-21015	0.00
 A metal suction tube with a 90-degree bend and a threaded end.	Suction Tubes HIC-21014	0.00
 A metal suction tube with a 90-degree bend and a threaded end.	Suction Tubes HIC-21013	0.00





	<p>Suction Tubes HIC-21012</p>	<p>0.00</p>
	<p>Suction Tubes HIC-21011</p>	<p>0.00</p>
	<p>Suction Tubes HIC-21010</p>	<p>0.00</p>
	<p>Suction Tubes HIC-21009</p>	<p>0.00</p>





	<p>Suction Tubes HIC-21008</p>	<p>0.00</p>
	<p>Suction Tubes HIC-21007</p>	<p>0.00</p>
	<p>Suction Tubes HIC-21006</p>	<p>0.00</p>
	<p>Suction Tubes HIC-21005</p>	<p>0.00</p>

	<p>Suction Tubes HIC-21004</p>	<p>0.00</p>
	<p>Suction Tubes HIC-21003</p>	<p>0.00</p>
	<p>Suction Tubes HIC-21002</p>	<p>0.00</p>
	<p>Suction Tubes HIC-21001</p>	<p>0.00</p>

Trocars

Product Image	Product Name	Price(\$)
 A stainless steel trocar with a long, thin shaft and a curved handle with a locking mechanism.	Trocars HIC-22012	0.00
 A stainless steel trocar with a long, thin shaft and a curved handle with a locking mechanism.	Trocars HIC-22011	0.00
 A stainless steel trocar with a long, thin shaft and a curved handle with a locking mechanism.	Trocars HIC-22010	0.00

	Trocars HIC-22009	0.00
	Trocars HIC-22008	0.00
	Trocars HIC-22007	0.00
	Trocars HIC-22006	0.00





 A long, thin, pointed surgical instrument with a curved handle and a locking mechanism at the end.	<p>Trocars HIC-22005</p>	<p>0.00</p>
 A long, thin, pointed surgical instrument with a curved handle and a locking mechanism at the end.	<p>Trocars HIC-22004</p>	<p>0.00</p>
 Two surgical instruments: a long, thin, pointed instrument with a T-shaped handle, and a similar instrument with a bulbous, teardrop-shaped handle.	<p>Trocars HIC-22003</p>	<p>0.00</p>
 Two surgical instruments: a long, thin, pointed instrument with a T-shaped handle, and a similar instrument with a bulbous, teardrop-shaped handle.	<p>Trocars HIC-22002</p>	<p>0.00</p>

	<p>Trocars HIC-22001</p>	<p>0.00</p>
---	------------------------------	-------------

DENTAL DIAGNOSTIC INSTRUMENTS

Dental Dressing Pliers





Product Image	Product Name	Price(\$)
	<p>Dental Dressing Pliers HIC-25009</p>	<p>0.00</p>
	<p>Dental Dressing Pliers HIC-25008</p>	<p>0.00</p>





	<p>Dental Dressing Pliers HIC-25007</p>	<p>0.00</p>
	<p>Dental Dressing Pliers HIC-25006</p>	<p>0.00</p>
	<p>Dental Dressing Pliers HIC-25005</p>	<p>0.00</p>
	<p>Dental Dressing Pliers HIC-25004</p>	<p>0.00</p>

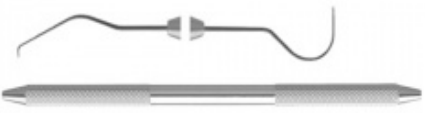



	<p>Dental Dressing Pliers HIC-25003</p>	<p>0.00</p>
	<p>Dental Dressing Pliers HIC-25002</p>	<p>0.00</p>
	<p>Dental Dressing Pliers HIC-25001</p>	<p>0.00</p>





Dental Explorers





Product Image	Product Name	Price(\$)



	<p>Dental Explorers HIC-26024</p>	<p>0.00</p>
	<p>HIC-26022</p>	<p>0.00</p>
	<p>Dental Explorers HIC-26023</p>	<p>0.00</p>
	<p>Dental Explorers HIC-26021</p>	<p>0.00</p>

	<p>Dental Explorers HIC-26020</p>	<p>0.00</p>
	<p>Dental Explorers HIC-26019</p>	<p>0.00</p>
	<p>Dental Explorers HIC-26018</p>	<p>0.00</p>
	<p>Dental Explorers HIC-26017</p>	<p>0.00</p>



	<p>Dental Explorers HIC-26016</p>	<p>0.00</p>
	<p>Dental Explorers HIC-26015</p>	<p>0.00</p>
	<p>Dental Explorers HIC-26014</p>	<p>0.00</p>
	<p>Dental Explorers HIC-26013</p>	<p>0.00</p>

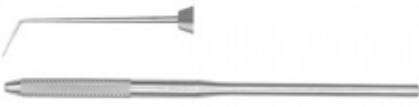



 <p>A dental explorer with a long, straight handle and a thin, curved tip.</p>	<p>Dental Explorers HIC-26012</p>	<p>0.00</p>
 <p>A dental explorer with a long, straight handle and a thin, curved tip.</p>	<p>Dental Explorers HIC-26011</p>	<p>0.00</p>
 <p>A dental explorer with a long, straight handle and a thin, curved tip.</p>	<p>Dental Explorers HIC-26010</p>	<p>0.00</p>
 <p>A dental explorer with a long, straight handle and a thin, curved tip.</p>	<p>Dental Explorers HIC-26009</p>	<p>0.00</p>





 A dental explorer tool with a long, thin handle and a curved, hook-like tip.	Dental Explorers HIC-26008	0.00
 A dental explorer tool with a long, thin handle and a curved, hook-like tip.	Dental Explorers HIC-26007	0.00
 A dental explorer tool with a long, thin handle and a curved, hook-like tip.	Dental Explorers HIC-26006	0.00
 A dental explorer tool with a long, thin handle and a curved, hook-like tip.	Dental Explorers HIC-26005	0.00





	<p>Dental Explorers HIC-26004</p>	<p>0.00</p>
	<p>Dental Explorers HIC-26003</p>	<p>0.00</p>
	<p>Dental Explorers HIC-26002</p>	<p>0.00</p>
	<p>Dental Explorers HIC-26001</p>	<p>0.00</p>



Dental Measuring Probes



Product Image	Product Name	Price(\$)
 A dental measuring probe with a long, thin shaft and a curved, hook-like tip. The handle is black with a silver-colored grip section.	Dental Measuring Probes HIC-27032	0.00
 A dental measuring probe with a long, thin shaft and a curved, hook-like tip. The handle is black with a silver-colored grip section.	Dental Measuring Probes HIC-27031	0.00
 A dental measuring probe with a long, thin shaft and a curved, hook-like tip. The handle is black with a silver-colored grip section.	Dental Measuring Probes HIC-27030	0.00

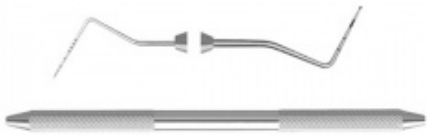

 <p>The image shows a dental measuring probe with a curved, hook-like tip and a long, thin handle. The handle has a small circular mark near the base of the probe.</p>	<p>Dental Measuring Probes HIC-27029</p>	<p>0.00</p>
 <p>The image shows a dental measuring probe with a curved, hook-like tip and a long, thin handle. The handle has a small circular mark near the base of the probe.</p>	<p>Dental Measuring Probes HIC-27028</p>	<p>0.00</p>
 <p>The image shows a dental measuring probe with a curved, hook-like tip and a long, thin handle. The handle has a small circular mark near the base of the probe.</p>	<p>Dental Measuring Probes HIC-27027</p>	<p>0.00</p>
 <p>The image shows a dental measuring probe with a curved, hook-like tip and a long, thin handle. The handle has a small circular mark near the base of the probe.</p>	<p>Dental Measuring Probes HIC-27026</p>	<p>0.00</p>

	<p>Dental Measuring Probes HIC-27025</p>	<p>0.00</p>
	<p>Dental Measuring Probes HIC-27024</p>	<p>0.00</p>
	<p>Dental Measuring Probes HIC-27023</p>	<p>0.00</p>
	<p>Dental Measuring Probes HIC-27022</p>	<p>0.00</p>

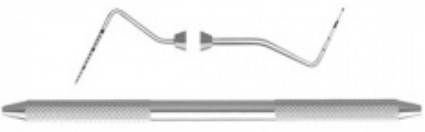
 The image shows two views of a dental measuring probe. The top view is a side profile of a thin, slightly curved metal rod with a small circular feature near the center. The bottom view is a top-down perspective of the same rod, showing its cylindrical shape and a small notch at the tip.	<p>Dental Measuring Probes HIC-27021</p>	<p>0.00</p>
 The image shows two views of a dental measuring probe. The top view is a side profile of a thin metal rod that is bent at a sharp angle near the tip. The bottom view is a top-down perspective of the rod, showing its cylindrical shape and a small notch at the tip.	<p>Dental Measuring Probes HIC-27020</p>	<p>0.00</p>
 The image shows two views of a dental measuring probe. The top view is a side profile of a thin metal rod that is bent at a sharp angle near the tip. The bottom view is a top-down perspective of the rod, showing its cylindrical shape and a small notch at the tip.	<p>Dental Measuring Probes HIC-27019</p>	<p>0.00</p>
 The image shows two views of a dental measuring probe. The top view is a side profile of a thin metal rod that is bent at a sharp angle near the tip. The bottom view is a top-down perspective of the rod, showing its cylindrical shape and a small notch at the tip.	<p>Dental Measuring Probes HIC-27018</p>	<p>0.00</p>

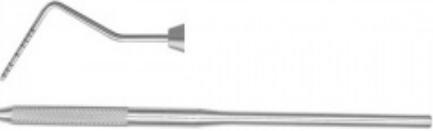
	<p>Dental Measuring Probes HIC-27017</p>	<p>0.00</p>
	<p>Dental Measuring Probes HIC-27016</p>	<p>0.00</p>
	<p>Dental Measuring Probes HIC-27015</p>	<p>0.00</p>
	<p>Dental Measuring Probes HIC-27014</p>	<p>0.00</p>

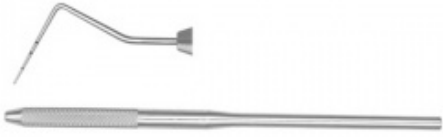
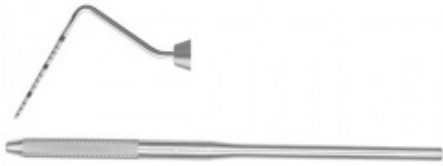
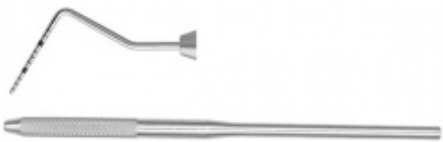
 <p>A dental measuring probe with a long, thin handle and a curved, hook-like tip. The handle has a small black band near the tip.</p>	<p>Dental Measuring Probes HIC-27013</p>	<p>0.00</p>
 <p>A dental measuring probe with a long, thin handle and a curved, hook-like tip. The handle has a small black band near the tip.</p>	<p>Dental Measuring Probes HIC-27012</p>	<p>0.00</p>
 <p>A dental measuring probe with a long, thin handle and a curved, hook-like tip. The handle has a small black band near the tip.</p>	<p>Dental Measuring Probes HIC-26011</p>	<p>0.00</p>
 <p>A dental measuring probe with a long, thin handle and a curved, hook-like tip. The handle has a small black band near the tip.</p>	<p>Dental Measuring Probes HIC-27010</p>	<p>0.00</p>

	<p>Dental Measuring Probes HIC-27009</p>	<p>0.00</p>
	<p>Dental Measuring Probes HIC-27008</p>	<p>0.00</p>
	<p>Dental Measuring Probes HIC-27007</p>	<p>0.00</p>
	<p>Dental Measuring Probes HIC-27006</p>	<p>0.00</p>

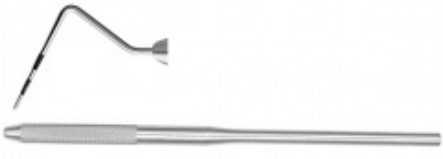
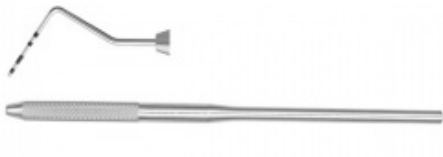
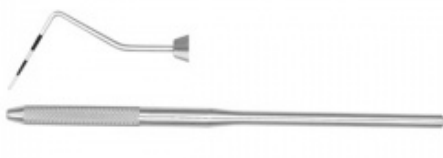
 A dental measuring probe with a long, thin handle and a curved, hook-like tip. The tip is shown in a side view, highlighting its curvature and the small hook at the end.	Dental Measuring Probes HIC-27005	0.00
 A dental measuring probe with a long, thin handle and a curved, hook-like tip. The tip is shown in a side view, highlighting its curvature and the small hook at the end.	Dental Measuring Probes HIC-27004	0.00
 A dental measuring probe with a long, thin handle and a curved, hook-like tip. The tip is shown in a side view, highlighting its curvature and the small hook at the end.	Dental Measuring Probes HIC-27003	0.00
 A dental measuring probe with a long, thin handle and a curved, hook-like tip. The tip is shown in a side view, highlighting its curvature and the small hook at the end.	Dental Measuring Probes HIC-27002	0.00

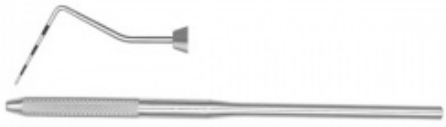
	<p>Dental Measuring Probes HIC-27001</p>	<p>0.00</p>
---	--	-------------

Dental Mirrors & Handles



Product Image	Product Name	Price(\$)
	<p>Dental Mirrors & Handles HIC-28004</p>	<p>0.00</p>
	<p>Dental Mirrors & Handles HIC-28003</p>	<p>0.00</p>

	<p>Dental Mirrors & Handles HIC-28002</p>	<p>0.00</p>
	<p>Dental Mirrors & Handles HIC-28001</p>	<p>0.00</p>

DENTAL EXTRACTION INSTRUMENTS





Aspirating Syringes





Product Image	Product Name	Price(\$)
	<p>Aspirating Syringes HIC-29003</p>	<p>0.00</p>



	<p>Aspirating Syringes HIC-29002</p>	<p>0.00</p>
	<p>Aspirating Syringes HIC-29001</p>	<p>0.00</p>





Dental Root Elevators

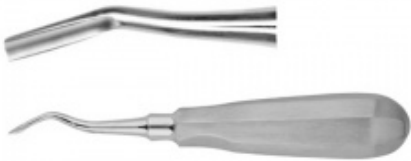
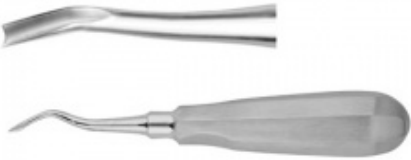



Product Image	Product Name	Price(\$)
	<p>Dental Root Elevators HIC-30061</p>	<p>0.00</p>





	<p>Dental Root Elevators HIC-30060</p>	<p>0.00</p>
	<p>Dental Root Elevators HIC-30059</p>	<p>0.00</p>
	<p>Dental Root Elevators HIC-30058</p>	<p>0.00</p>
	<p>Dental Root Elevators HIC-30057</p>	<p>0.00</p>





	<p>Dental Root Elevators HIC-30056</p>	<p>0.00</p>
	<p>Dental Root Elevators HIC-30055</p>	<p>0.00</p>
	<p>Dental Root Elevators HIC-30054</p>	<p>0.00</p>
	<p>Dental Root Elevators HIC-30053</p>	<p>0.00</p>





	<p>Dental Root Elevators HIC-30052</p>	<p>0.00</p>
	<p>Dental Root Elevators HIC-30051</p>	<p>0.00</p>
	<p>Dental Root Elevators HIC-30050</p>	<p>0.00</p>
	<p>Dental Root Elevators HIC-30049</p>	<p>0.00</p>



	<p>Dental Root Elevators HIC-30048</p>	<p>0.00</p>
	<p>Dental Root Elevators HIC-30047</p>	<p>0.00</p>
	<p>Dental Root Elevators HIC-30046</p>	<p>0.00</p>
	<p>Dental Root Elevators HIC-30045</p>	<p>0.00</p>

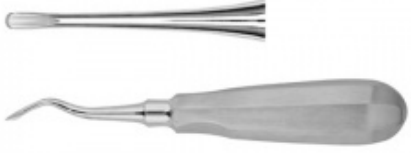

	<p>Dental Root Elevators HIC-30044</p>	<p>0.00</p>
	<p>Dental Root Elevators HIC-30043</p>	<p>0.00</p>
	<p>Dental Root Elevators HIC-30042</p>	<p>0.00</p>
	<p>Dental Root Elevators HIC-30041</p>	<p>0.00</p>

	<p>Dental Root Elevators HIC-30040</p>	<p>0.00</p>
	<p>Dental Root Elevators HIC-30038</p>	<p>0.00</p>
	<p>Dental Root Elevators HIC-30037</p>	<p>0.00</p>
	<p>Dental Root Elevators HIC-30036</p>	<p>0.00</p>

 <p>Two dental root elevators are shown. The top one has a flat, rectangular blade. The bottom one has a curved, hook-like blade. Both have long, tapered handles.</p>	<p>Dental Root Elevators HIC-30035</p>	<p>0.00</p>
 <p>Two dental root elevators are shown. The top one has a curved, hook-like blade. The bottom one has a curved, hook-like blade. Both have long, tapered handles.</p>	<p>Dental Root Elevators HIC-30034</p>	<p>0.00</p>
 <p>Two dental root elevators are shown. The top one has a curved, hook-like blade. The bottom one has a curved, hook-like blade. Both have long, tapered handles.</p>	<p>Dental Root Elevators HIC-30033</p>	<p>0.00</p>
 <p>Two dental root elevators are shown. The top one has a curved, hook-like blade. The bottom one has a curved, hook-like blade. Both have long, tapered handles.</p>	<p>Dental Root Elevators HIC-30032</p>	<p>0.00</p>



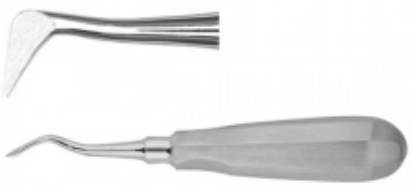

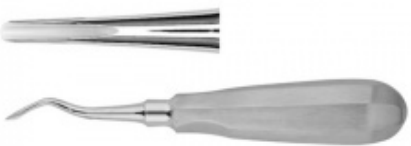
	<p>Dental Root Elevators HIC-30031</p>	<p>0.00</p>
	<p>Dental Root Elevators HIC-30030</p>	<p>0.00</p>
	<p>Dental Root Elevators HIC-30029</p>	<p>0.00</p>
	<p>Dental Root Elevators HIC-30028</p>	<p>0.00</p>





	<p>Dental Root Elevators HIC-30027</p>	<p>0.00</p>
	<p>Dental Root Elevators HIC-30026</p>	<p>0.00</p>
	<p>Dental Root Elevators HIC-30025</p>	<p>0.00</p>
	<p>Dental Root Elevators HIC-30024</p>	<p>0.00</p>



 <p>The image shows two dental root elevators. The top one is a straight elevator with a curved, hook-like tip. The bottom one is a similar straight elevator but with a long, ergonomically shaped handle.</p>	<p>Dental Root Elevators HIC-30023</p>	<p>0.00</p>
 <p>The image shows two dental root elevators. The top one is a straight elevator with a curved, hook-like tip. The bottom one is a similar straight elevator but with a long, ergonomically shaped handle.</p>	<p>Dental Root Elevators HIC-30022</p>	<p>0.00</p>
 <p>The image shows two dental root elevators. The top one is a straight elevator with a curved, hook-like tip. The bottom one is a similar straight elevator but with a long, ergonomically shaped handle.</p>	<p>Dental Root Elevators HIC-30021</p>	<p>0.00</p>
 <p>The image shows two dental root elevators. The top one is a straight elevator with a curved, hook-like tip. The bottom one is a similar straight elevator but with a long, ergonomically shaped handle.</p>	<p>Dental Root Elevators HIC-30020</p>	<p>0.00</p>

	<p>Dental Root Elevators HIC-30019</p>	<p>0.00</p>
	<p>Dental Root Elevators HIC-30018</p>	<p>0.00</p>
	<p>Dental Root Elevators HIC-30017</p>	<p>0.00</p>
	<p>Dental Root Elevators HIC-30016</p>	<p>0.00</p>

 A dental root elevator with a long, tapered handle and a curved, hook-like tip. The head is made of metal and has a small, flat, triangular blade at the end.	<p>Dental Root Elevators HIC-30015</p>	<p>0.00</p>
 A dental root elevator with a long, tapered handle and a curved, hook-like tip. The head is made of metal and has a small, flat, triangular blade at the end.	<p>Dental Root Elevators HIC-30014</p>	<p>0.00</p>
 A dental root elevator with a long, tapered handle and a curved, hook-like tip. The head is made of metal and has a small, flat, triangular blade at the end.	<p>Dental Root Elevators HIC-30013</p>	<p>0.00</p>
 A dental root elevator with a long, tapered handle and a curved, hook-like tip. The head is made of metal and has a small, flat, triangular blade at the end.	<p>Dental Root Elevators HIC-30012</p>	<p>0.00</p>

	<p>Dental Root Elevators HIC-30011</p>	<p>0.00</p>
	<p>Dental Root Elevators HIC-30010</p>	<p>0.00</p>
	<p>Dental Root Elevators HIC-30009</p>	<p>0.00</p>
	<p>Dental Root Elevators HIC-30008</p>	<p>0.00</p>



	<p>Dental Root Elevators HIC-30007</p>	<p>0.00</p>
	<p>Dental Root Elevators HIC-30006</p>	<p>0.00</p>
	<p>Dental Root Elevators HIC-30005</p>	<p>0.00</p>
	<p>Dental Root Elevators HIC-30004</p>	<p>0.00</p>

	<p>Dental Root Elevators HIC-30003</p>	<p>0.00</p>
	<p>Dental Root Elevators HIC-30002</p>	<p>0.00</p>
	<p>Dental Root Elevators HIC-30001</p>	<p>0.00</p>





ORTHODONTIC INSTRUMENTS

Orthodontic Plier

Product Image	Product Name	Price(\$)
	<p>Orthodontic Pliers</p>	<p>0.00</p>





	Orthodontic Plier HIC-31027	0.00
	Orthodontic Plier HIC-31026	0.00
	Orthodontic Plier HIC-31025	0.00
	Orthodontic Plier HIC-31024	0.00



	Orthodontic Plier HIC-31023	0.00
	Orthodontic Plier HIC-31022	0.00
	Orthodontic Plier HIC-31021	0.00
	Orthodontic Plier HIC-31020	0.00

	<p>Orthodontic Plier HIC-31019</p>	<p>0.00</p>
	<p>Orthodontic Plier HIC-31018</p>	<p>0.00</p>
	<p>Orthodontic Plier HIC-31017</p>	<p>0.00</p>
	<p>Orthodontic Plier HIC-31016</p>	<p>0.00</p>

	Orthodontic Plier HIC-31015	0.00
	Orthodontic Plier HIC-31014	0.00
	Orthodontic Plier HIC-31013	0.00
	Orthodontic Plier HIC-31012	0.00



	Orthodontic Plier HIC-31011	0.00
	Orthodontic Plier HIC-31010	0.00
	Orthodontic Plier HIC-31009	0.00
	Orthodontic Plier HIC-31008	0.00

	Orthodontic Plier HIC-31007	0.00
	Orthodontic Plier HIC-31006	0.00
	Orthodontic Plier HIC-31005	0.00
	Orthodontic Plier HIC-31004	0.00

	<p>Orthodontic Plier HIC-31003</p>	<p>0.00</p>
	<p>Orthodontic Plier HIC-31002</p>	<p>0.00</p>
	<p>Orthodontic Plier HIC-31001</p>	<p>0.00</p>





Orthodontic Band Instruments

Product Image	Product Name	Price(\$)

	<p>Orthodontic Band Instruments HIC-32003</p>	<p>0.00</p>
	<p>Orthodontic Band Instruments HIC-32002</p>	<p>0.00</p>
	<p>Orthodontic Band Instruments HIC-32001</p>	<p>0.00</p>

Orthodontic Ligature Instruments

Product Image	Product Name	Price(\$)

	<p>Orthodontic Ligature Instruments HIC-33006</p>	<p>0.00</p>
	<p>Orthodontic Ligature Instruments HIC-33005</p>	<p>0.00</p>
	<p>Orthodontic Ligature Instruments HIC-33003</p>	<p>0.00</p>
	<p>Orthodontic Ligature Instruments HIC-33002</p>	<p>0.00</p>

	<p>Orthodontic Ligature Instruments HIC-33001</p>	<p>0.00</p>
---	---	-------------



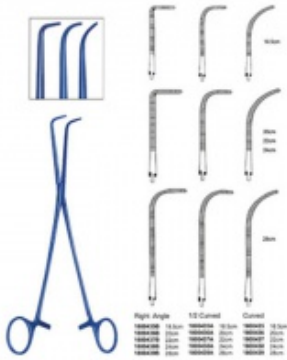

TITANIUM INSTRUMENTS





Clamps

Product Image	Product Name	Price(\$)
	<p>Clamps HIC-34001</p>	<p>0.00</p>



Curette Vascular Dilator





Product Image	Product Name	Price(\$)
	<p>Curette Vascular Dilator HIC-35009</p>	<p>0.00</p>





	Curette Vascular Dilator HIC-35008	0.00
	Curette Vascular Dilator HIC-35007	0.00
	Curette Vascular Dilator HIC-35006	0.00
	Curette Vascular Dilator HIC-35005	0.00





	<p>Curette Vascular Dilator HIC-35004</p>	<p>0.00</p>
	<p>Curette Vascular Dilator HIC-35003</p>	<p>0.00</p>
	<p>Curette Vascular Dilator HIC-35002</p>	<p>0.00</p>
 	<p>Curette Vascular Dilator HIC-35001</p>	<p>0.00</p>





Dissectors

Product Image	Product Name	Price(\$)
	Dissectors HIC-36021	0.00
	Dissectors HIC-36020	0.00
	Dissectors HIC-36019	0.00

 A blue surgical dissector with a long, thin handle and a curved, hook-like tip.	Dissectors HIC-36018	0.00
 A blue surgical dissector with a long, thin handle and a straight tip.	Dissectors HIC-36017	0.00
 A blue surgical dissector with a long, thin handle and a straight tip.	Dissectors HIC-36016	0.00
 A blue surgical dissector with a long, thin handle and a straight tip.	Dissectors HIC-36015	0.00



	Dissectors HIC-36014	0.00
	Dissectors HIC-36013	0.00
	Dissectors HIC-36012	0.00
	Dissectors HIC-36011	0.00





	Dissectors HIC-36010	0.00
	Dissectors HIC-36009	0.00
	Dissectors HIC-36008	0.00
	Dissectors HIC-36007	0.00





 A blue-handled surgical dissector with a long, thin, slightly curved metal shaft and a small hook-like tip.	Dissectors HIC-36006	0.00
 A blue-handled surgical dissector with a long, thin, slightly curved metal shaft and a small hook-like tip.	Dissectors HIC-36005	0.00
 A blue-handled surgical dissector with a long, thin, slightly curved metal shaft and a small hook-like tip.	Dissectors HIC-36004	0.00
 A blue-handled surgical dissector with a long, thin, slightly curved metal shaft and a small hook-like tip.	Dissectors HIC-36001	0.00



	<p>Dissectors HIC-36003</p>	<p>0.00</p>
---	---------------------------------	-------------





Forceps



Product Image	Product Name	Price(\$)
	<p>Forceps HIC-37037</p>	<p>0.00</p>
	<p>Forceps HIC-37036</p>	<p>0.00</p>





	Forceps HIC-37035	0.00
	Forceps HIC-37034	0.00
	Forceps HIC-37033	0.00
	Forceps HIC-37032	0.00





	Forceps HIC-37031	0.00
	Forceps HIC-37030	0.00
	Forceps HIC-37029	0.00
	Forceps HIC-37028	0.00

	Forceps HIC-37027	0.00
	Forceps HIC-37026	0.00
	Forceps HIC-37025	0.00
	Forceps HIC-37024	0.00

	<p>Forceps HIC-37023</p>	<p>0.00</p>
	<p>Forceps HIC-37022</p>	<p>0.00</p>
	<p>Forceps HIC-37021</p>	<p>0.00</p>
	<p>Forceps HIC-37020</p>	<p>0.00</p>

	<p>Forceps HIC-37019</p>	<p>0.00</p>
	<p>Forceps HIC-37018</p>	<p>0.00</p>
	<p>Forceps HIC-37017</p>	<p>0.00</p>
	<p>Forceps HIC-37016</p>	<p>0.00</p>

	<p>Forceps HIC-37015</p>	<p>0.00</p>
	<p>Forceps HIC-37014</p>	<p>0.00</p>
	<p>Forceps HIC-37013</p>	<p>0.00</p>
	<p>Forceps HIC-37012</p>	<p>0.00</p>

	<p>Forceps HIC-37011</p>	<p>0.00</p>
	<p>Forceps HIC-37010</p>	<p>0.00</p>
	<p>Forceps HIC-37009</p>	<p>0.00</p>
	<p>Forceps HIC-37008</p>	<p>0.00</p>

	<p>Forceps HIC-37007</p>	<p>0.00</p>
	<p>Forceps HIC-37006</p>	<p>0.00</p>
	<p>Forceps HIC-37005</p>	<p>0.00</p>
	<p>Forceps HIC-37003</p>	<p>0.00</p>

	<p>Forceps HIC-37002</p>	<p>0.00</p>
	<p>Forceps HIC-37001</p>	<p>0.00</p>



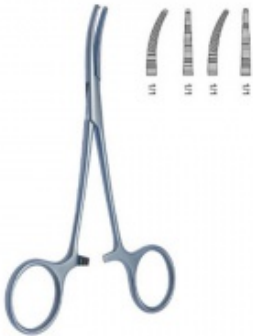

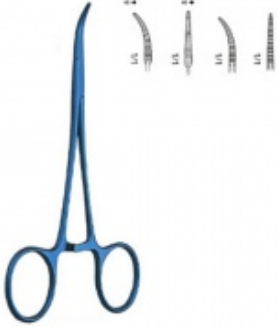
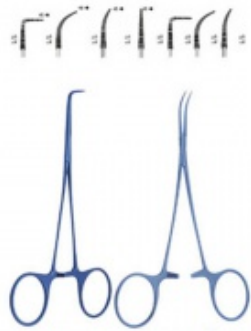
Haemostatic Forceps





Product Image	Product Name	Price(\$)
	<p>Haemostatic Forceps HIC-38003</p>	<p>0.00</p>





	<p>Haemostatic Forceps HIC-38002</p>	<p>0.00</p>
	<p>Haemostatic Forceps HIC-38001</p>	<p>0.00</p>





Needle Holder

Product Image	Product Name	Price(\$)
	<p>Needle Holder HIC-39018</p>	<p>0.00</p>

	Needle Holder HIC-39017	0.00
	Needle Holder HIC-39016	0.00
	Needle Holder HIC-39015	0.00
	Needle Holder HIC-39014	0.00

	Needle Holder HIC-39013	0.00
	Needle Holder HIC-39012	0.00
	Needle Holder HIC-39011	0.00
	Needle Holder HIC-39010	0.00

	Needle Holder HIC-39009	0.00
	Needle Holder HIC-39008	0.00
	Needle Holder HIC-39007	0.00
	Needle Holder HIC-39006	0.00

	Needle Holder HIC-39005	0.00
	Needle Holder HIC-39004	0.00
	Needle Holder HIC-39003	0.00
	Needle Holder HIC-39002	0.00



	<p>Needle Holder HIC-39001</p>	<p>0.00</p>
---	------------------------------------	-------------

Olsen Hegar Needle Holder

Product Image	Product Name	Price(\$)
	<p>Olsen Hegar Needle Holder HIC-40001</p>	<p>0.00</p>

Pediatric Clamps

Product Image	Product Name	Price(\$)
	<p>Pediatric Clamps HIC-41004</p>	<p>0.00</p>

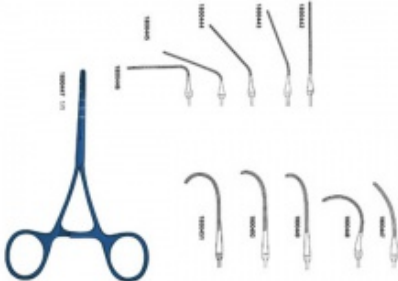



	<p>Pediatric Clamps HIC-41003</p>	<p>0.00</p>
	<p>Pediatric Clamps HIC-41002</p>	<p>0.00</p>
	<p>Pediatric Clamps HIC-41001</p>	<p>0.00</p>

Retractor



Product Image	Product Name	Price(\$)





	<p>Retractor HIC-42012</p>	<p>0.00</p>
	<p>Retractor HIC-42011</p>	<p>0.00</p>
	<p>Retractor HIC-42010</p>	<p>0.00</p>
	<p>Retractor HIC-42009</p>	<p>0.00</p>



 A blue metal retractor with two vertical arms and a central horizontal bar with a serrated edge. A handle is attached to the bottom of the central bar.	Retractor HIC-42008	0.00
 A black metal retractor with two vertical arms and a central horizontal bar with a serrated edge. A handle is attached to the bottom of the central bar.	Retractor HIC-42007	0.00
 A blue metal retractor with two vertical arms and a central horizontal bar with a serrated edge. Two small rectangular components are shown floating above the main assembly.	Retractor HIC-42006	0.00
 A blue metal retractor consisting of a long horizontal bar with a handle at one end and a loop of wire at the other.	Retractor HIC-42005	0.00

	<p>Retractor HIC-42004</p>	<p>0.00</p>
	<p>Retractor HIC-42003</p>	<p>0.00</p>
	<p>Retractor HIC-42002</p>	<p>0.00</p>
	<p>Retractor HIC-42001</p>	<p>0.00</p>

Ring Handle Needle Holder





Product Image	Product Name	Price(\$)
	Ring Handle Needle Holder HIC-43009	0.00
	Ring Handle Needle Holder HIC-43008	0.00
	Ring Handle Needle Holder HIC-43007	0.00





	Ring Handle Needle Holder HIC-43006	0.00
	Ring Handle Needle Holder HIC-43005	0.00
	Ring Handle Needle Holder HIC-43004	0.00
	Ring Handle Needle Holder HIC-43003	0.00





	<p>Ring Handle Needle Holder HIC-43002</p>	<p>0.00</p>
	<p>Ring Handle Needle Holder HIC-43001</p>	<p>0.00</p>





Scissors



Product Image	Product Name	Price(\$)
	<p>Scissors HIC-44021</p>	<p>0.00</p>

	Scissors HIC-44020	0.00
	Scissors HIC-44019	0.00
	Scissors HIC-44018	0.00
	Scissors HIC-44017	0.00



	<p>Scissors HIC-44016</p>	<p>0.00</p>
	<p>Scissors HIC-44015</p>	<p>0.00</p>
	<p>Scissors HIC-44014</p>	<p>0.00</p>
	<p>Scissors HIC-44013</p>	<p>0.00</p>



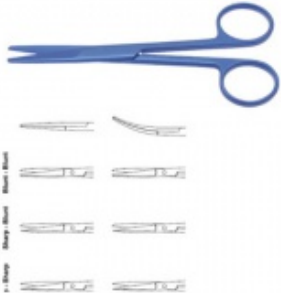

	Scissors HIC-44012	0.00
	Scissors HIC-44011	0.00
	Scissors HIC-44010	0.00
	Scissors HIC-44009	0.00

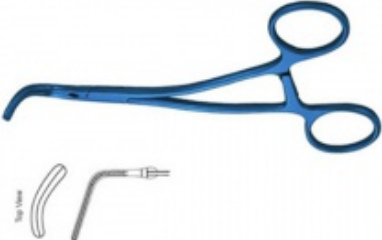
	Scissors HIC-44008	0.00
	Scissors HIC-44007	0.00
	Scissors HIC-44006	0.00
	Scissors HIC-44005	0.00

	<p>Scissors HIC-44004</p>	<p>0.00</p>
	<p>Scissors HIC-44003</p>	<p>0.00</p>
	<p>Scissors HIC-44002</p>	<p>0.00</p>
	<p>Scissors HIC-44001</p>	<p>0.00</p>

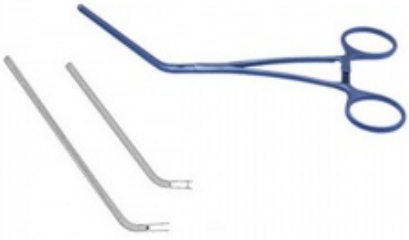
Vascular Clamps

Product Image	Product Name	Price(\$)
 A blue surgical vascular clamp with long, curved jaws and two finger loops.	Vascular Clamps HIC-45009	0.00
 A blue surgical vascular clamp with long, curved jaws and two finger loops. Below the main image are two smaller diagrams: one showing a curved jaw and another showing a different view of the jaw tip.	Vascular Clamps HIC-45008	0.00
 A blue surgical vascular clamp with long, curved jaws and two finger loops, featuring a different jaw design than the previous models.	Vascular Clamps HIC-45007	0.00

	<p>Vascular Clamps HIC-45006</p>	<p>0.00</p>
	<p>Vascular Clamps HIC-45005</p>	<p>0.00</p>
	<p>Vascular Clamps HIC-45004</p>	<p>0.00</p>
	<p>Vascular Clamps HIC-45003</p>	<p>0.00</p>

	<p>Vascular Clamps HIC-45002</p>	<p>0.00</p>
	<p>Vascular Clamps HIC-45001</p>	<p>0.00</p>

Vascular Hook





Product Image	Product Name	Price(\$)
	<p>Vascular Hook HIC-46003</p>	<p>0.00</p>

	<p>Vascular Hook HIC-46002</p>	<p>0.00</p>
	<p>Vascular Hook HIC-46001</p>	<p>0.00</p>

THORAX & CARDIOVASCULAR INSTRUMENTS

Aortic Aneurysm Clamps

Product Image	Product Name	Price(\$)
	<p>Aortic Aneurysm Clamps HIC-51006</p>	<p>0.00</p>

	<p>Aortic Aneurysm Clamps HIC-51005</p>	<p>0.00</p>
	<p>Aortic Aneurysm Clamps HIC-51004</p>	<p>0.00</p>
	<p>Aortic Aneurysm Clamps HIC-51003</p>	<p>0.00</p>
	<p>Aortic Aneurysm Clamps HIC-51002</p>	<p>0.00</p>

	<p>Aortic Aneurysm Clamps HIC-51001</p>	<p>0.00</p>
---	---	-------------



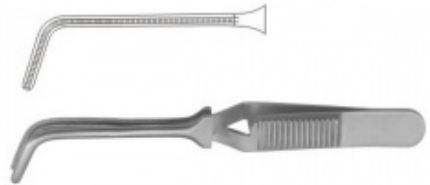

Atrauma Bulldog Clamps





Product Image	Product Name	Price(\$)
	<p>Atrauma Bulldog Clamps HIC-52025</p>	<p>0.00</p>
	<p>Atrauma Bulldog Clamps HIC-52024</p>	<p>0.00</p>

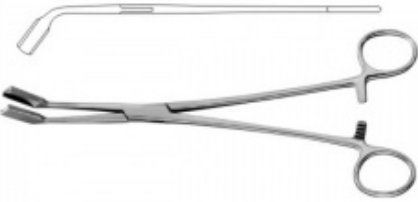

	<p>Atrauma Bulldog Clamps HIC-52023</p>	<p>0.00</p>
	<p>Atrauma Bulldog Clamps HIC-52022</p>	<p>0.00</p>
	<p>Atrauma Bulldog Clamps HIC-52021</p>	<p>0.00</p>
	<p>Atrauma Bulldog Clamps HIC-52020</p>	<p>0.00</p>

 <p>Atrauma Bulldog Clamps HIC-52019</p>	0.00
 <p>Atrauma Bulldog Clamps HIC-52018</p>	0.00
 <p>Atrauma Bulldog Clamps HIC-52017</p>	0.00
 <p>Atrauma Bulldog Clamps HIC-52016</p>	0.00

	<p>Atrauma Bulldog Clamps HIC-52015</p>	<p>0.00</p>
	<p>Atrauma Bulldog Clamps HIC-52014</p>	<p>0.00</p>
	<p>Atrauma Bulldog Clamps HIC-52013</p>	<p>0.00</p>
	<p>Atrauma Bulldog Clamps HIC-52012</p>	<p>0.00</p>



	<p>Atrauma Bulldog Clamps HIC-52011</p>	<p>0.00</p>
	<p>Atrauma Bulldog Clamps HIC-52010</p>	<p>0.00</p>
	<p>Atrauma Bulldog Clamps HIC-52009</p>	<p>0.00</p>
	<p>Atrauma Bulldog Clamps HIC-52008</p>	<p>0.00</p>



	<p>Atrauma Bulldog Clamps HIC-52007</p>	<p>0.00</p>
	<p>Atrauma Bulldog Clamps HIC-52006</p>	<p>0.00</p>
	<p>Atrauma Bulldog Clamps HIC-52005</p>	<p>0.00</p>
	<p>Atrauma Bulldog Clamps HIC-52004</p>	<p>0.00</p>

	<p>Atrauma Bulldog Clamps HIC-52003</p>	<p>0.00</p>
	<p>Atrauma Bulldog Clamps HIC-52002</p>	<p>0.00</p>
	<p>Atrauma Bulldog Clamps HIC-52001</p>	<p>0.00</p>

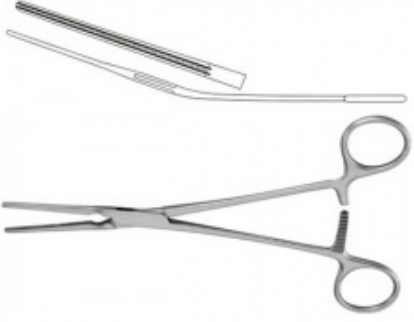
Coarctation Clamps

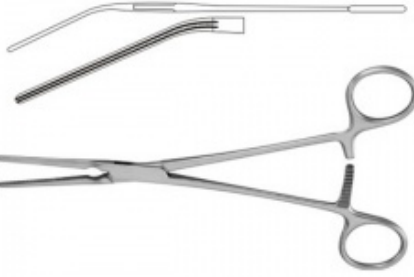
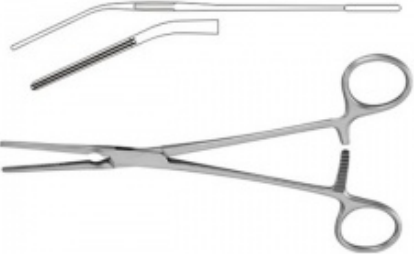

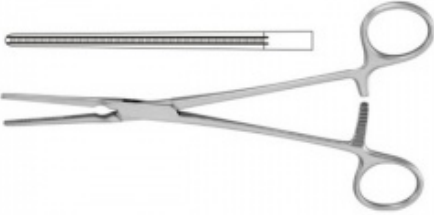
Product Image	Product Name	Price(\$)

	<p>Coarctation Clamps HIC-53006</p>	<p>0.00</p>
	<p>Coarctation Clamps HIC-53005</p>	<p>0.00</p>
	<p>Coarctation Clamps HIC-53004</p>	<p>0.00</p>
	<p>Coarctation Clamps HIC-53003</p>	<p>0.00</p>



	<p>Coarctation Clamps HIC-53002</p>	<p>0.00</p>
	<p>Coarctation Clamps HIC-53001</p>	<p>0.00</p>

Dissecting Forceps

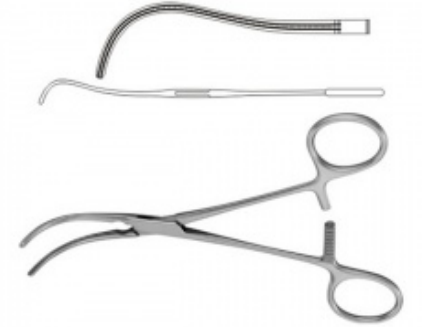

Product Image	Product Name	Price(\$)
	<p>Dissecting Forceps HIC-54005</p>	<p>0.00</p>

	<p>Dissecting Forceps HIC-54004</p>	<p>0.00</p>
	<p>Dissecting Forceps HIC-54003</p>	<p>0.00</p>
	<p>Dissecting Forceps HIC-54002</p>	<p>0.00</p>
	<p>Dissecting Forceps HIC-54001</p>	<p>0.00</p>

Hemostatic Forceps

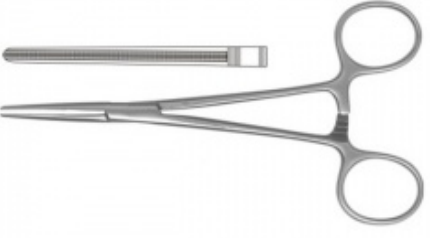
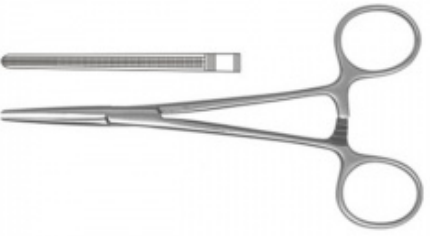
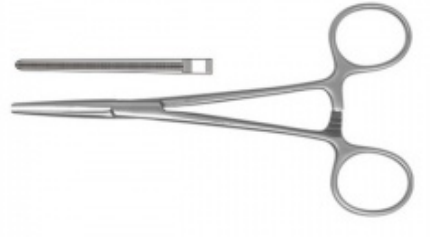
Product Image	Product Name	Price(\$)
 A pair of hemostatic forceps with long, curved jaws and two circular handles. A small black curved object is positioned above the jaws.	Hemostatic Forceps HIC-55012	0.00
 A pair of hemostatic forceps with long, curved jaws and two circular handles. A small black curved object is positioned above the jaws.	Hemostatic Forceps HIC-55012	0.00
 A pair of hemostatic forceps with long, curved jaws and two circular handles. A small black curved object is positioned above the jaws.	Hemostatic Forceps HIC-55011	0.00

 A pair of hemostatic forceps with long, tapered jaws and two circular handles. A small, thin metal rod is positioned horizontally above the upper jaw.	<p>Hemostatic Forceps HIC-55010</p>	<p>0.00</p>
 A pair of hemostatic forceps with long, tapered jaws and two circular handles. A small, thin metal rod is positioned horizontally above the upper jaw.	<p>Hemostatic Forceps HIC-55009</p>	<p>0.00</p>
 A pair of hemostatic forceps with long, tapered jaws and two circular handles. A small, thin metal rod is positioned horizontally above the upper jaw.	<p>Hemostatic Forceps HIC-55008</p>	<p>0.00</p>
 A pair of hemostatic forceps with long, tapered jaws and two circular handles. A small, thin metal rod is positioned horizontally above the upper jaw.	<p>Hemostatic Forceps HIC-55007</p>	<p>0.00</p>

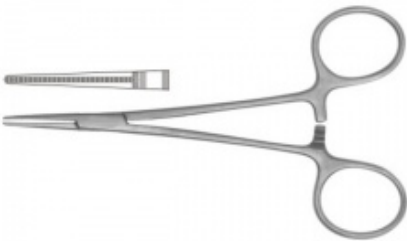
	<p>Hemostatic Forceps HIC-55006</p>	<p>0.00</p>
	<p>Hemostatic Forceps HIC-55005</p>	<p>0.00</p>
	<p>Hemostatic Forceps HIC-55004</p>	<p>0.00</p>
	<p>Hemostatic Forceps HIC-55003</p>	<p>0.00</p>

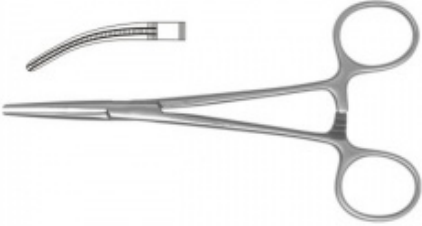
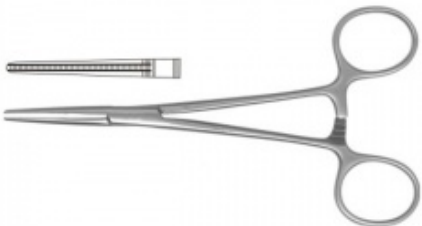

	<p>Hemostatic Forceps HIC-55002</p>	<p>0.00</p>
	<p>Hemostatic Forceps HIC-55001</p>	<p>0.00</p>

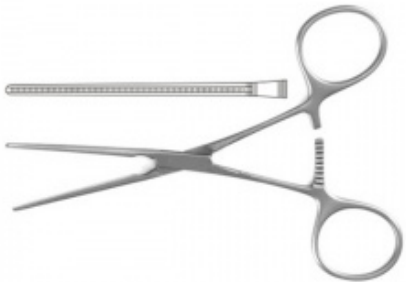

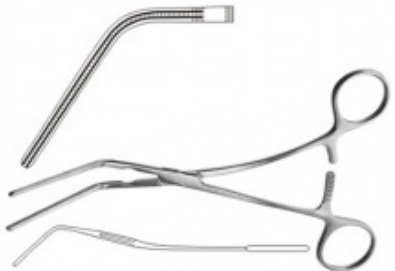
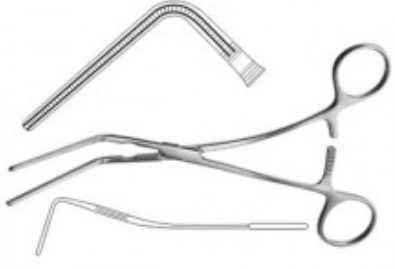
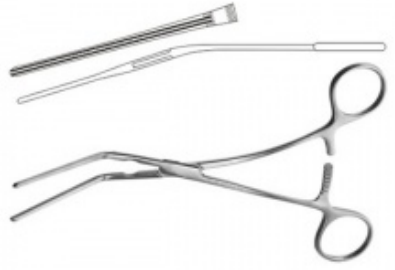

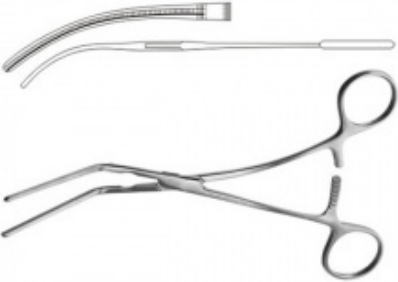
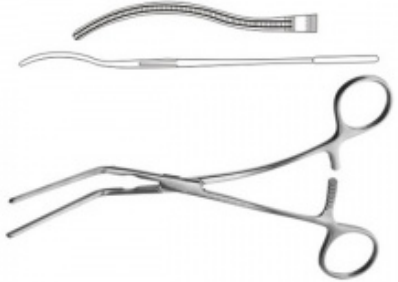
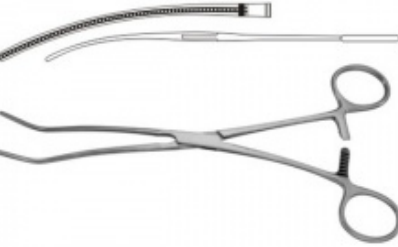
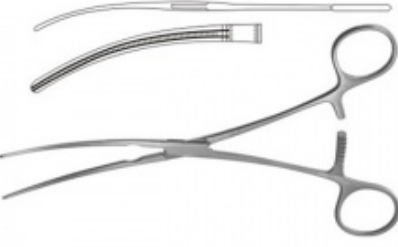
Vascular Clamps

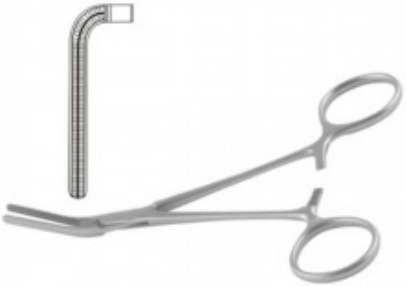

Product Image	Product Name	Price(\$)
	<p>Vascular Clamps HIC-56030</p>	<p>0.00</p>

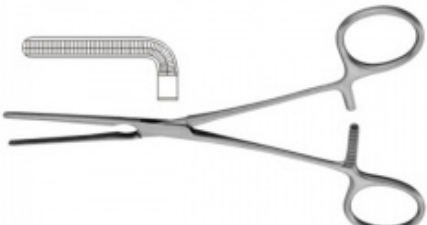

	<p>Vascular Clamps HIC-56029</p>	<p>0.00</p>
	<p>Vascular Clamps HIC-56028</p>	<p>0.00</p>
	<p>Vascular Clamps HIC-56027</p>	<p>0.00</p>
	<p>Vascular Clamps HIC-56026</p>	<p>0.00</p>

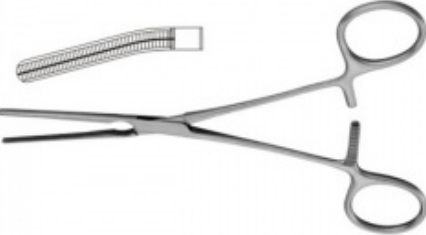

	Vascular Clamps HIC-56025	0.00
	Vascular Clamps HIC-56024	0.00
	Vascular Clamps HIC-56023	0.00
	Vascular Clamps HIC-56022	0.00

	<p>Vascular Clamps HIC-56021</p>	<p>0.00</p>
	<p>Vascular Clamps HIC-56020</p>	<p>0.00</p>
	<p>Vascular Clamps HIC-56019</p>	<p>0.00</p>
	<p>Vascular Clamps HIC-56018</p>	<p>0.00</p>

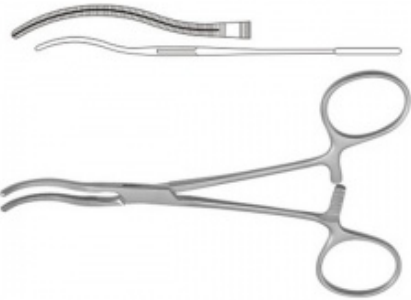
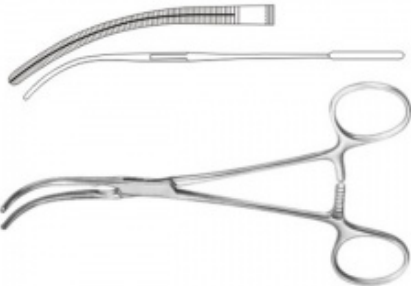
	<p>Vascular Clamps HIC-56017</p>	<p>0.00</p>
	<p>Vascular Clamps HIC-56016</p>	<p>0.00</p>
	<p>Vascular Clamps HIC-56015</p>	<p>0.00</p>
	<p>Vascular Clamps HIC-56014</p>	<p>0.00</p>

	<p>Vascular Clamps HIC-56013</p>	<p>0.00</p>
	<p>Vascular Clamps HIC-56012</p>	<p>0.00</p>
	<p>Vascular Clamps HIC-56011</p>	<p>0.00</p>
	<p>Vascular Clamps HIC-56010</p>	<p>0.00</p>

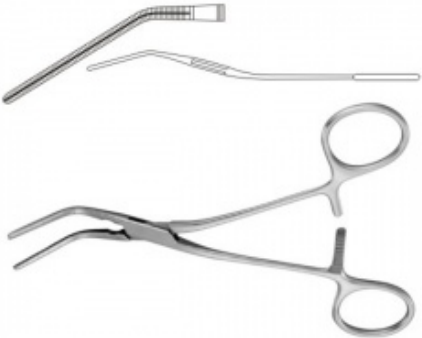
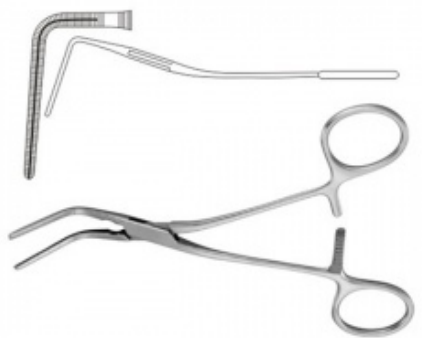
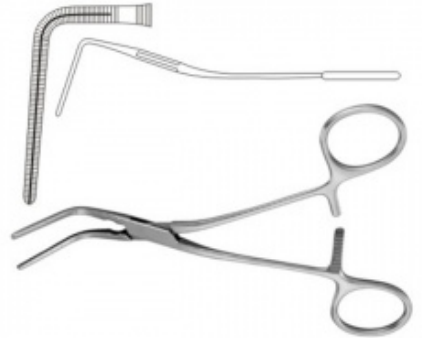

	<p>Vascular Clamps HIC-56009</p>	<p>0.00</p>
	<p>Vascular Clamps HIC-56008</p>	<p>0.00</p>
	<p>Vascular Clamps HIC-56007</p>	<p>0.00</p>
	<p>Vascular Clamps HIC-56006</p>	<p>0.00</p>

	<p>Vascular Clamps HIC-56005</p>	<p>0.00</p>
	<p>Vascular Clamps HIC-56004</p>	<p>0.00</p>
	<p>Vascular Clamps HIC-56003</p>	<p>0.00</p>
	<p>Vascular Clamps HIC-56002</p>	<p>0.00</p>

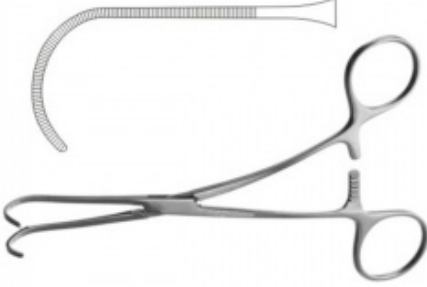
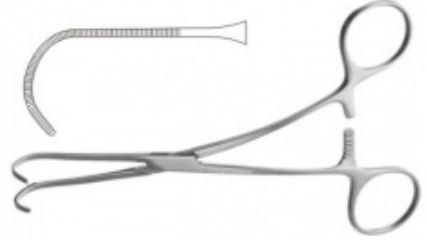

	<p>Vascular Clamps HIC-56001</p>	<p>0.00</p>
---	--------------------------------------	-------------

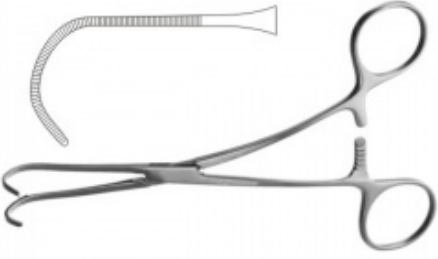
Neonatal Vascular Clamps

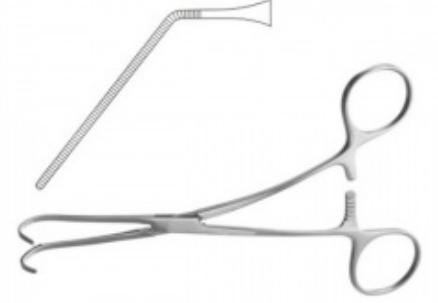
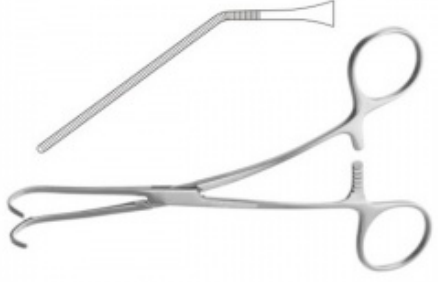

Product Image	Product Name	Price(\$)
	<p>Neonatal Vascular Clamps HIC-57006</p>	<p>0.00</p>
	<p>Neonatal Vascular Clamps HIC-57005</p>	<p>0.00</p>

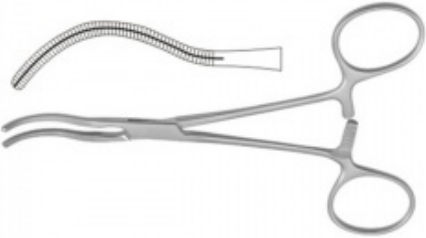
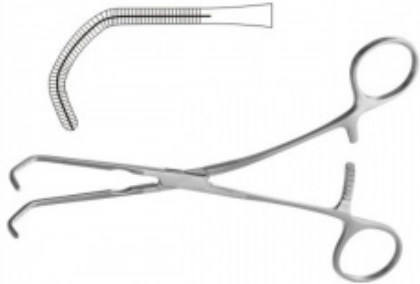
	<p>Neonatal Vascular Clamps HIC-57004</p>	<p>0.00</p>
	<p>Neonatal Vascular Clamps HIC-57003</p>	<p>0.00</p>
	<p>Neonatal Vascular Clamps HIC-57002</p>	<p>0.00</p>
	<p>Neonatal Vascular Clamps HIC-57001</p>	<p>0.00</p>

Pediatric Vascular Clamps

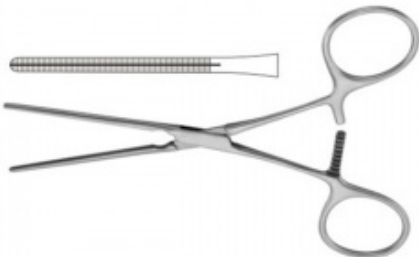
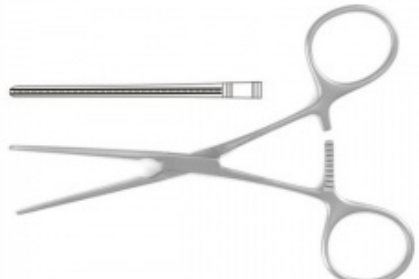
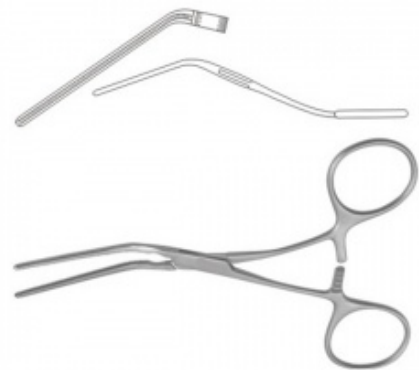

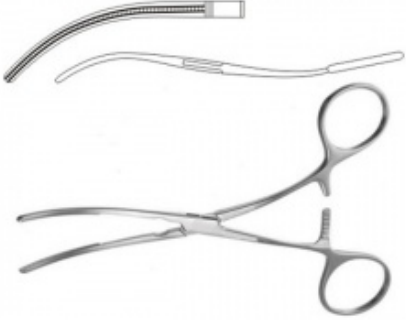
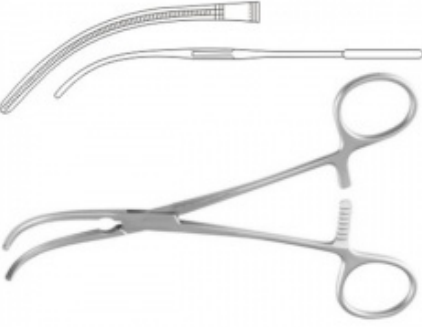
Product Image	Product Name	Price(\$)
 A pair of pediatric vascular clamps with a curved, mesh-covered tip and a white rectangular marker at the end of the tip. The handles are standard surgical forceps.	Pediatric Vascular Clamps HIC-58012	0.00
 A pair of pediatric vascular clamps with a curved, mesh-covered tip and a white rectangular marker at the end of the tip. The handles are standard surgical forceps.	Pediatric Vascular Clamps HIC-58011	0.00
 A pair of pediatric vascular clamps with a curved, mesh-covered tip and a white rectangular marker at the end of the tip. The handles are standard surgical forceps.	Pediatric Vascular Clamps HIC-58010	0.00

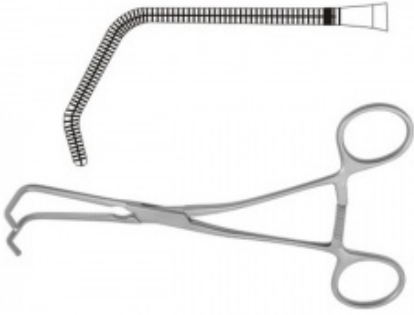

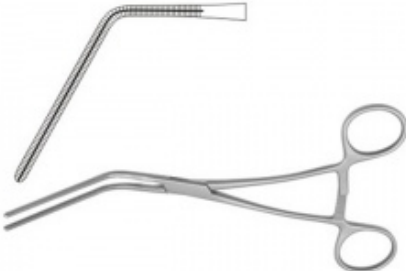

	<p>Pediatric Vascular Clamps HIC-58009</p>	<p>0.00</p>
	<p>Pediatric Vascular Clamps HIC-58008</p>	<p>0.00</p>
	<p>Pediatric Vascular Clamps HIC-58007</p>	<p>0.00</p>
	<p>Pediatric Vascular Clamps HIC-58006</p>	<p>0.00</p>



	<p>Pediatric Vascular Clamps HIC-58005</p>	<p>0.00</p>
	<p>Pediatric Vascular Clamps HIC-58004</p>	<p>0.00</p>
	<p>Pediatric Vascular Clamps HIC-58003</p>	<p>0.00</p>
	<p>Pediatric Vascular Clamps HIC-58002</p>	<p>0.00</p>





	<p>Pediatric Vascular Clamps HIC-58001</p>	<p>0.00</p>
---	--	-------------

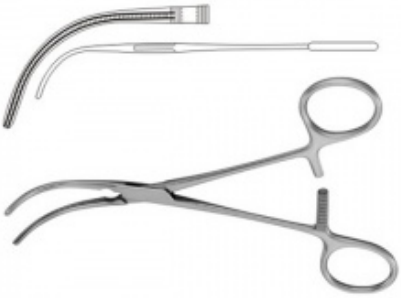
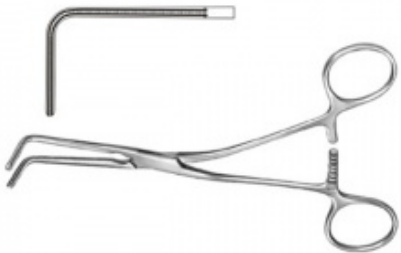

Peripheral Vascular Clamps

Product Image	Product Name	Price(\$)
	<p>Peripheral Vascular Clamps HIC-59018</p>	<p>0.00</p>
	<p>Peripheral Vascular Clamps HIC-59017</p>	<p>0.00</p>



	<p>Peripheral Vascular Clamps HIC-59016</p>	<p>0.00</p>
	<p>Peripheral Vascular Clamps HIC-59015</p>	<p>0.00</p>
	<p>Peripheral Vascular Clamps HIC-59014</p>	<p>0.00</p>
	<p>Peripheral Vascular Clamps HIC-59013</p>	<p>0.00</p>

	<p>Peripheral Vascular Clamps HIC-59012</p>	<p>0.00</p>
	<p>Peripheral Vascular Clamps HIC-59011</p>	<p>0.00</p>
	<p>Peripheral Vascular Clamps HIC-59010</p>	<p>0.00</p>
	<p>Peripheral Vascular Clamps HIC-59009</p>	<p>0.00</p>

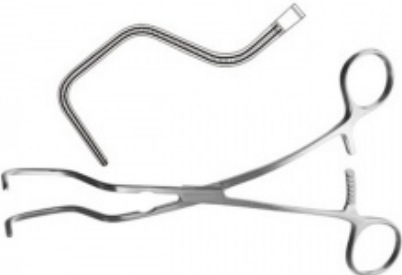
	<p>Peripheral Vascular Clamps HIC-59008</p>	<p>0.00</p>
	<p>Peripheral Vascular Clamps HIC-59007</p>	<p>0.00</p>
	<p>Peripheral Vascular Clamps HIC-59006</p>	<p>0.00</p>
	<p>Peripheral Vascular Clamps HIC-59005</p>	<p>0.00</p>

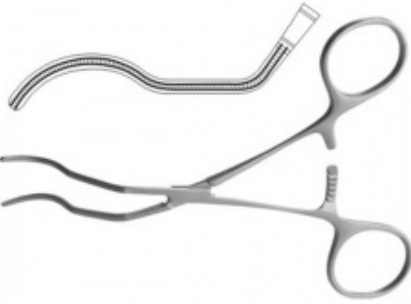

	<p>Peripheral Vascular Clamps HIC-59004</p>	<p>0.00</p>
	<p>Peripheral Vascular Clamps HIC-59003</p>	<p>0.00</p>
	<p>Peripheral Vascular Clamps HIC-59002</p>	<p>0.00</p>
	<p>Peripheral Vascular Clamps HIC-59001</p>	<p>0.00</p>

Atrauma Profunda Clamps



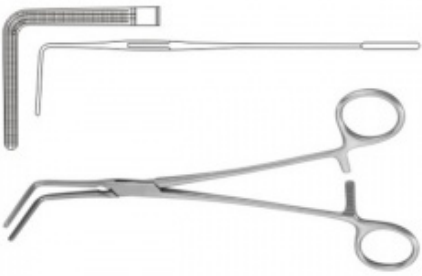
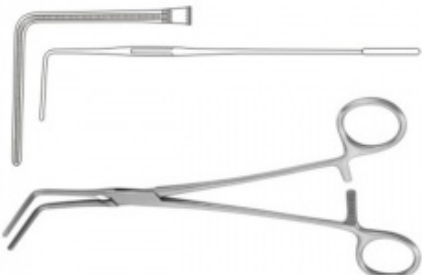

Product Image	Product Name	Price(\$)
	Atrauma Profunda Clamps HIC-60003	0.00
	Atrauma Profunda Clamps HIC-60002	0.00
	Atrauma Profunda Clamps HIC-60001	0.00

Atrauma Vascular Clamps

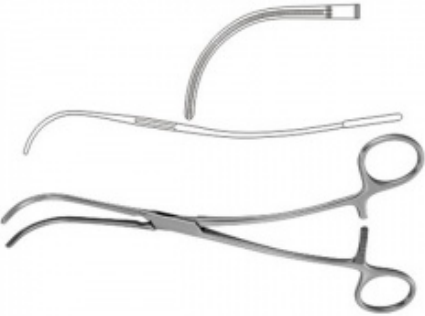
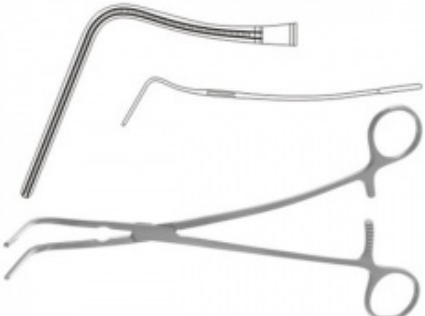
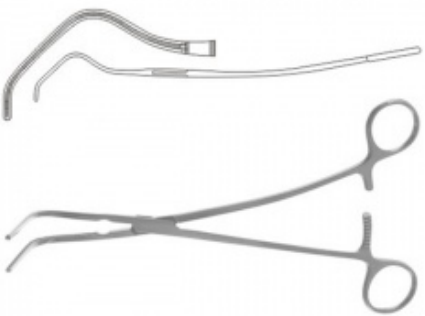
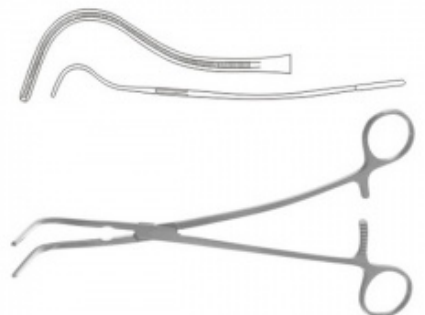
Product Image	Product Name	Price(\$)

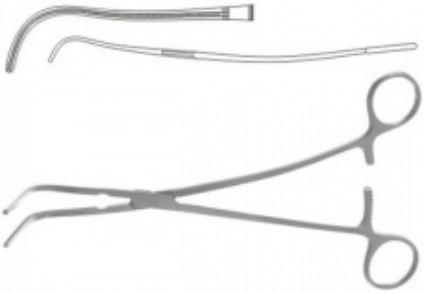

	<p>Atrauma Vascular Clamps HIC-61012</p>	<p>0.00</p>
	<p>Atrauma Vascular Clamps HIC-61011</p>	<p>0.00</p>
	<p>Atrauma Vascular Clamps HIC-61010</p>	<p>0.00</p>
	<p>Atrauma Vascular Clamps HIC-61009</p>	<p>0.00</p>

	<p>Atrauma Vascular Clamps HIC-61008</p>	<p>0.00</p>
	<p>Atrauma Vascular Clamps HIC-61007</p>	<p>0.00</p>
	<p>Atrauma Vascular Clamps HIC-61006</p>	<p>0.00</p>
	<p>Atrauma Vascular Clamps HIC-61005</p>	<p>0.00</p>

	<p>Atrauma Vascular Clamps HIC-61004</p>	<p>0.00</p>
	<p>Atrauma Vascular Clamps HIC-61003</p>	<p>0.00</p>
	<p>Atrauma Vascular Clamps HIC-61002</p>	<p>0.00</p>
	<p>Atrauma Vascular Clamps HIC-61001</p>	<p>0.00</p>

Bronchus Clamps

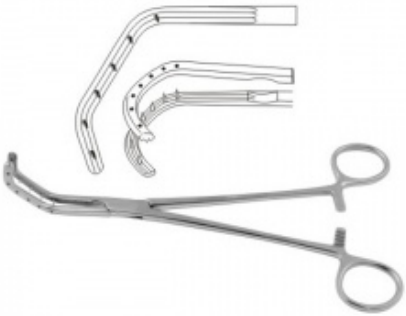
Product Image	Product Name	Price(\$)
 A pair of surgical forceps with long, thin, curved jaws and two finger loops. A separate curved metal clamp is shown above the forceps.	Bronchus Clamps HIC-62005	0.00
 A pair of surgical forceps with long, thin, curved jaws and two finger loops. A separate curved metal clamp is shown above the forceps.	Bronchus Clamps HIC-62004	0.00
 A pair of surgical forceps with long, thin, curved jaws and two finger loops. Two separate curved metal clamps are shown above the forceps.	Bronchus Clamps HIC-62003	0.00



	<p>Bronchus Clamps HIC-62002</p>	<p>0.00</p>
	<p>Bronchus Clamps HIC-62001</p>	<p>0.00</p>

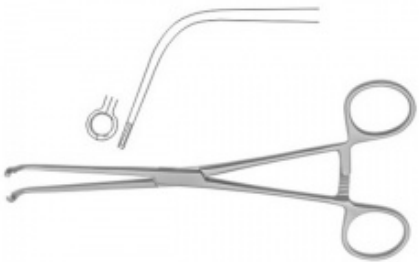

Carotid Shunt Clamps

Product Image	Product Name	Price(\$)
	<p>Carotid Shunt Clamps HIC-63001</p>	<p>0.00</p>

	<p>Carotid Shunt Clamps HIC-63002</p>	<p>0.00</p>
---	---	-------------





Facsiotomy Instruments

Product Image	Product Name	Price(\$)
	<p>Facsiotomy Instruments HIC-64005</p>	<p>0.00</p>
	<p>Facsiotomy Instruments HIC-64004</p>	<p>0.00</p>

	<p>Facsiotomy Instruments HIC-64003</p>	<p>0.00</p>
	<p>Facsiotomy Instruments HIC-64002</p>	<p>0.00</p>
	<p>Facsiotomy Instruments HIC-64001</p>	<p>0.00</p>

Intima Spatulas

Product Image	Product Name	Price(\$)

	<p>Intima Spatulas HIC-65004</p>	<p>0.00</p>
	<p>Intima Spatulas HIC-65003</p>	<p>0.00</p>
	<p>Intima Spatulas HIC-65002</p>	<p>0.00</p>
	<p>Intima Spatulas HIC-65001</p>	<p>0.00</p>

Ligature Catchers

Product Image	Product Name	Price(\$)
 A long, thin metal instrument with a circular handle on the right and a hook-like tip on the left. A smaller, similar instrument is shown above it for scale.	Ligature Catchers HIC-66004	0.00
 A long, thin metal instrument with a circular handle on the right and a hook-like tip on the left. A smaller, similar instrument is shown above it for scale.	Ligature Catchers HIC-66003	0.00
 A long, thin metal instrument with a circular handle on the right and a hook-like tip on the left. A smaller, similar instrument is shown above it for scale.	Ligature Catchers HIC-66002	0.00



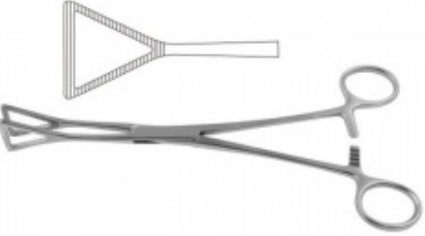

	<p>Ligature Catchers HIC-66001</p>	<p>0.00</p>
---	--	-------------

Lung Grasping Forceps



Product Image	Product Name	Price(\$)
	<p>Lung Grasping Forceps HIC-67002</p>	<p>0.00</p>
	<p>Lung Grasping Forceps HIC-67001</p>	<p>0.00</p>



Rib Contractors

Product Image	Product Name	Price(\$)
	<p>Product Name</p>	<p>Price(\$)</p>

	<p>Rib Contractors HIC-68004</p>	<p>0.00</p>
	<p>Rib Contractors HIC-68003</p>	<p>0.00</p>
	<p>Rib Contractors HIC-68002</p>	<p>0.00</p>
	<p>Rib Contractors HIC-68001</p>	<p>0.00</p>

Rib Shears

Product Image	Product Name	Price(\$)
 A pair of stainless steel rib shears with long, curved handles and a sharp, pointed beak.	Rib Shears HIC-69006	0.00
 A pair of stainless steel rib shears with long, curved handles and a sharp, pointed beak, similar to HIC-69006 but with a slightly different handle design.	Rib Shears HIC-69005	0.00
 A pair of stainless steel rib shears with long, curved handles and a sharp, pointed beak, similar to HIC-69005 but with a different handle design.	Rib Shears HIC-69004	0.00

	<p>Rib Shears HIC-69003</p>	<p>0.00</p>
	<p>Rib Shears HIC-69002</p>	<p>0.00</p>
	<p>Rib Shears HIC-69001</p>	<p>0.00</p>

Rib Spreaders, Rib Retractors

Product Image	Product Name	Price(\$)

	<p>Rib Spreaders, Rib Retractors HIC-70018</p>	<p>0.00</p>
	<p>Rib Spreaders, Rib Retractors HIC-70017</p>	<p>0.00</p>
	<p>Rib Spreaders, Rib Retractors HIC-70016</p>	<p>0.00</p>
	<p>Rib Spreaders, Rib Retractors HIC-70015</p>	<p>0.00</p>

	<p>Rib Spreaders, Rib Retractors HIC-70014</p>	<p>0.00</p>
	<p>Rib Spreaders, Rib Retractors HIC-70013</p>	<p>0.00</p>
	<p>Rib Spreaders, Rib Retractors HIC-70012</p>	<p>0.00</p>
	<p>Rib Spreaders, Rib Retractors HIC-70011</p>	<p>0.00</p>

	Rib Spreaders, Rib Retractors HIC-70010	0.00
	Rib Spreaders, Rib Retractors HIC-70009	0.00
	Rib Spreaders, Rib Retractors HIC-70008	0.00
	Rib Spreaders, Rib Retractors HIC-70007	0.00

	<p>Rib Spreaders, Rib Retractors HIC-70006</p>	<p>0.00</p>
	<p>Rib Spreaders, Rib Retractors HIC-70005</p>	<p>0.00</p>
	<p>Rib Spreaders, Rib Retractors HIC-70004</p>	<p>0.00</p>
	<p>Rib Spreaders, Rib Retractors HIC-70003</p>	<p>0.00</p>



	<p>Rib Spreaders, Rib Retractors HIC-70002</p>	<p>0.00</p>
	<p>Rib Spreaders, Rib Retractors HIC-70001</p>	<p>0.00</p>





Tourniquets





Product Image	Product Name	Price(\$)
	<p>Tourniquets HIC-71001</p>	<p>0.00</p>

	<p>Tourniquets HIC-71002</p>	<p>0.00</p>
---	----------------------------------	-------------

Vascular Dilators

Product Image	Product Name	Price(\$)
	<p>Vascular Dilators HIC-72012</p>	<p>0.00</p>
	<p>Vascular Dilators HIC-72011</p>	<p>0.00</p>



 A long, thin, cylindrical metal rod with a textured, cylindrical handle at the right end.	Vascular Dilators HIC-72010	0.00
 A long, thin, cylindrical metal rod with a textured, cylindrical handle at the right end.	Vascular Dilators HIC-72009	0.00
 A long, thin, cylindrical metal rod with a textured, cylindrical handle at the right end.	Vascular Dilators HIC-72008	0.00
 A long, thin, cylindrical metal rod with a textured, cylindrical handle at the right end.	Vascular Dilators HIC-72007	0.00

 A long, thin, cylindrical metal rod with a textured, cylindrical handle at the right end.	Vascular Dilators HIC-72006	0.00
 A long, thin, cylindrical metal rod with a textured, cylindrical handle at the right end.	Vascular Dilators HIC-72005	0.00
 A long, thin, cylindrical metal rod with a textured, cylindrical handle at the right end.	Vascular Dilators HIC-72004	0.00
 A long, thin, cylindrical metal rod with a textured, cylindrical handle at the right end.	Vascular Dilators HIC-72003	0.00

	<p>Vascular Dilators HIC-72002</p>	<p>0.00</p>
	<p>Vascular Dilators HIC-72001</p>	<p>0.00</p>

Vascular Dissectors

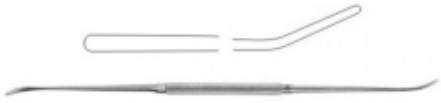
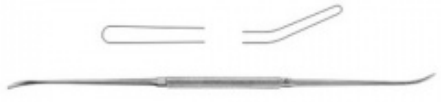



Product Image	Product Name	Price(\$)
	<p>Vascular Dissectors HIC-73004</p>	<p>0.00</p>



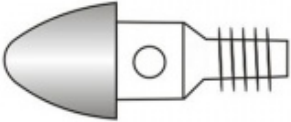
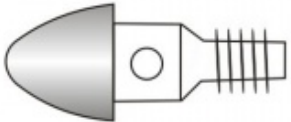
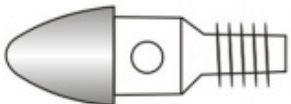

	<p>Vascular Dissectors HIC-73003</p>	<p>0.00</p>
	<p>Vascular Dissectors HIC-73002</p>	<p>0.00</p>
	<p>Vascular Dissectors HIC-73001</p>	<p>0.00</p>

Tunneling Instruments

Product Image	Product Name	Price(\$)

	Tunneling Instruments HIC-74012	0.00
	Tunneling Instruments HIC-74011	0.00
	Tunneling Instruments HIC-74010	0.00
	Tunneling Instruments HIC-74009	0.00



 A technical drawing of a tunneling instrument with a conical tip, a circular opening, and a threaded section.	Tunneling Instruments HIC-74008	0.00
 A technical drawing of a tunneling instrument with a conical tip, a circular opening, and a threaded section.	Tunneling Instruments HIC-74007	0.00
 A technical drawing of a tunneling instrument with a conical tip, a circular opening, and a threaded section.	Tunneling Instruments HIC-74006	0.00
 A simple curved line representing a tunneling instrument.	Tunneling Instruments HIC-74005	0.00

	<p>Tunneling Instruments HIC-74004</p>	<p>0.00</p>
	<p>Tunneling Instruments HIC-74003</p>	<p>0.00</p>
	<p>Tunneling Instruments HIC-74002</p>	<p>0.00</p>
	<p>Tunneling Instruments HIC-74001</p>	<p>0.00</p>

DERMATOLOGY INSTRUMENTS



Comedone Extractors

Product Image	Product Name	Price(\$)
 A long, thin, silver-colored metal instrument with a central shaft and two curved, pointed ends. The ends are slightly curved outwards. There are small diagrams above the instrument showing the tip's profile and a cross-section of the shaft.	Comedone Extractors HIC-76006	0.00
 A long, thin, silver-colored metal instrument with a central shaft and two curved, pointed ends. The ends are slightly curved outwards. There are small diagrams above the instrument showing the tip's profile and a cross-section of the shaft.	Comedone Extractors HIC-76005	0.00
 A long, thin, silver-colored metal instrument with a central shaft and two curved, pointed ends. The ends are slightly curved outwards. There are small diagrams above the instrument showing the tip's profile and a cross-section of the shaft.	Comedone Extractors HIC-76004	0.00

	<p>Comedone Extractors HIC-76003</p>	<p>0.00</p>
	<p>Comedone Extractors HIC-76002</p>	<p>0.00</p>
	<p>Comedone Extractors HIC-76001</p>	<p>0.00</p>

Dermal Biopsy Punche

Product Image	Product Name	Price(\$)

	<p>Dermal Biopsy Punche HIC-77003</p>	<p>0.00</p>
	<p>Dermal Biopsy Punche HIC-77002</p>	<p>0.00</p>
	<p>Dermal Biopsy Punche HIC-77001</p>	<p>0.00</p>

Face-Lift Hooks

Product Image	Product Name	Price(\$)

	<p>Face-Lift Hooks HIC-78002</p>	<p>0.00</p>
	<p>Face-Lift Hooks HIC-78001</p>	<p>0.00</p>

Lupus Scrapers and Curettes

Product Image	Product Name	Price(\$)
	<p>Lupus Scrapers and Curettes HIC-79003</p>	<p>0.00</p>

	<p>Lupus Scrapers and Curettes HIC-79002</p>	<p>0.00</p>
	<p>Lupus Scrapers and Curettes HIC-79001</p>	<p>0.00</p>





Milium Knives



Product Image	Product Name	Price(\$)
	<p>Milium Knives HIC-80001</p>	<p>0.00</p>

ORTHOPEDIC INSTRUMENTS

Autopsy (Postmortem) Instruments

Product Image	Product Name	Price(\$)

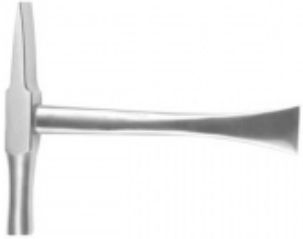
	Autopsy (Postmortem) Instruments HIC-81006	0.00
	Autopsy (Postmortem) Instruments HIC-81005	0.00
	Autopsy (Postmortem) Instruments HIC-81004	0.00
	Autopsy (Postmortem) Instruments HIC-81003	0.00

	<p>Autopsy (Postmortem) Instruments HIC-81002</p>	<p>0.00</p>
	<p>Autopsy (Postmortem) Instruments HIC-81001</p>	<p>0.00</p>



Bone Chisels

Product Image	Product Name	Price(\$)
	<p>Bone Chisels HIC-82009</p>	<p>0.00</p>



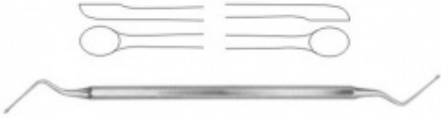
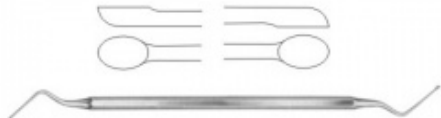

 A bone chisel with a flat, rectangular metal head and a smooth, rounded wooden handle.	<p>Bone Chisels HIC-82008</p>	<p>0.00</p>
 A bone chisel with a slightly curved metal head and a smooth, rounded wooden handle.	<p>Bone Chisels HIC-82007</p>	<p>0.00</p>
 A bone chisel with a flat, rectangular metal head and a smooth, rounded wooden handle.	<p>Bone Chisels HIC-82006</p>	<p>0.00</p>
 A long, narrow, tapered metal chisel with a small rectangular notch at the top left end.	<p>Bone Chisels HIC-82005</p>	<p>0.00</p>

 <p>A bone chisel with a long, tapered handle and a flat, rectangular head. The head is shown in two views: a top view and a side view.</p>	<p>Bone Chisels HIC-82004</p>	<p>0.00</p>
 <p>A bone chisel with a long, tapered handle and a flat, rectangular head. The head is shown in two views: a top view and a side view.</p>	<p>Bone Chisels HIC-82003</p>	<p>0.00</p>
 <p>A bone chisel with a long, tapered handle and a flat, rectangular head. The head is shown in two views: a top view and a side view.</p>	<p>Bone Chisels HIC-82002</p>	<p>0.00</p>
 <p>A bone chisel with a long, tapered handle and a flat, rectangular head. The head is shown in two views: a top view and a side view.</p>	<p>Bone Chisels HIC-82001</p>	<p>0.00</p>

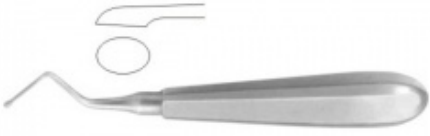

Bone Curettes

Product Image	Product Name	Price(\$)
 The illustration shows three dental instruments. At the top are two smaller instruments with circular handles and flat, slightly curved blades. Below them is a larger instrument with a long, thin handle and a long, narrow blade that has a curved, hook-like tip at each end.	Bone Curettes HIC-83018	0.00
 The illustration shows three dental instruments. At the top are two smaller instruments with circular handles and flat, slightly curved blades. Below them is a larger instrument with a long, thin handle and a long, narrow blade that has a curved, hook-like tip at each end.	Bone Curettes HIC-83017	0.00
 The illustration shows two dental instruments. The top one is a smaller instrument with a curved handle and a curved blade. The bottom one is a larger instrument with a long, thin handle and a long, narrow blade that has a curved, hook-like tip at each end.	Bone Curettes HIC-83016	0.00

	<p>Bone Curettes HIC-83015</p>	<p>0.00</p>
	<p>Bone Curettes HIC-83014</p>	<p>0.00</p>
	<p>Bone Curettes HIC-83013</p>	<p>0.00</p>
	<p>Bone Curettes HIC-83012</p>	<p>0.00</p>

 A photograph of a bone curette with a curved, hook-like tip and a long, tapered handle. A technical line drawing of the same instrument is shown above the photograph.	<p>Bone Currettes HIC-83011</p>	<p>0.00</p>
 A photograph of a bone curette with a straight, pointed tip and a long, tapered handle. A technical line drawing of the same instrument is shown above the photograph.	<p>Bone Currettes HIC-83010</p>	<p>0.00</p>
 A photograph of a bone curette with a straight, pointed tip and a long, tapered handle. A technical line drawing of the same instrument is shown above the photograph.	<p>Bone Currettes HIC-83009</p>	<p>0.00</p>
 A photograph of a bone curette with a rounded, hook-like tip and a long, tapered handle with a dark, possibly wooden or composite, grip.	<p>Bone Currettes HIC-83008</p>	<p>0.00</p>





	<p>Bone Curettes HIC-83007</p>	<p>0.00</p>
	<p>Bone Curettes HIC-83006</p>	<p>0.00</p>
	<p>Bone Curettes HIC-83005</p>	<p>0.00</p>
	<p>Bone Curettes HIC-83004</p>	<p>0.00</p>





	<p>Bone Currettes HIC-83003</p>	<p>0.00</p>
	<p>Bone Currettes HIC-83002</p>	<p>0.00</p>
	<p>Bone Currettes HIC-83001</p>	<p>0.00</p>

Bone Gouges

Product Image	Product Name	Price(\$)
	<p>Placeholder for Bone Gouge name</p>	<p>Placeholder for Bone Gouge price</p>

	<p>Bone Gouges HIC-84015</p>	<p>0.00</p>
	<p>Bone Gouges HIC-84014</p>	<p>0.00</p>
	<p>Bone Gouges HIC-84013</p>	<p>0.00</p>
	<p>Bone Gouges HIC-84012</p>	<p>0.00</p>



 A bone gouge with a long, tapered metal shaft and a dark, textured handle. A small inset image shows the tip of the tool.	<p>Bone Gouges HIC-84011</p>	<p>0.00</p>
 A bone gouge with a long, tapered metal shaft and a dark, textured handle. A small inset image shows the tip of the tool.	<p>Bone Gouges HIC-84010</p>	<p>0.00</p>
 A bone gouge with a long, tapered metal shaft and a dark, textured handle. A small inset image shows the tip of the tool.	<p>Bone Gouges HIC-84009</p>	<p>0.00</p>
 A bone gouge with a long, tapered metal shaft and a dark, textured handle. A small inset image shows the tip of the tool.	<p>Bone Gouges HIC-84008</p>	<p>0.00</p>

 <p>A bone gouge with a long, tapered handle and a curved, hook-like tip. A small inset diagram shows the tip's profile.</p>	<p>Bone Gouges HIC-84007</p>	<p>0.00</p>
 <p>A bone gouge with a long, tapered handle and a curved, hook-like tip. A small inset diagram shows the tip's profile.</p>	<p>Bone Gouges HIC-84006</p>	<p>0.00</p>
 <p>A bone gouge with a long, tapered handle and a curved, hook-like tip. A small inset diagram shows the tip's profile.</p>	<p>Bone Gouges HIC-84005</p>	<p>0.00</p>
 <p>A bone gouge with a long, tapered handle and a curved, hook-like tip. A small inset diagram shows the tip's profile.</p>	<p>Bone Gouges HIC-84004</p>	<p>0.00</p>

	<p>Bone Gouges HIC-84003</p>	<p>0.00</p>
	<p>Bone Gouges HIC-84002</p>	<p>0.00</p>
	<p>Bone Gouges HIC-84001</p>	<p>0.00</p>



Bone Holding Clamps



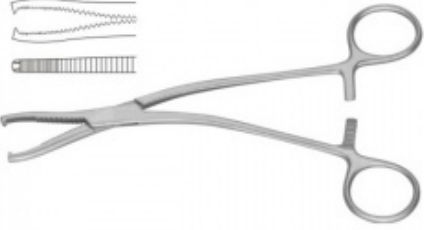
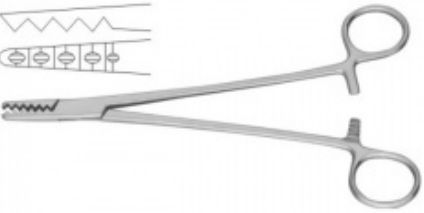
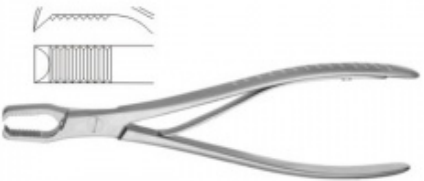

Product Image	Product Name	Price(\$)

	<p>Bone Holding Clamps HIC-85003</p>	<p>0.00</p>
	<p>Bone Holding Clamps HIC-85002</p>	<p>0.00</p>
	<p>Bone Holding Clamps HIC-85001</p>	<p>0.00</p>

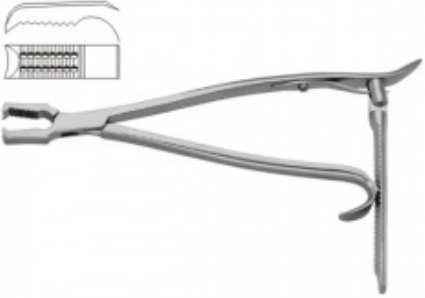

Bone Holding Forceps



Product Image	Product Name	Price(\$)

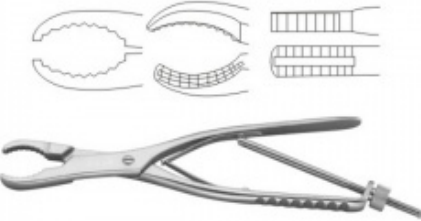
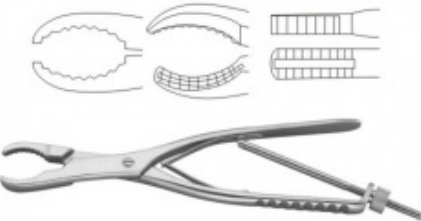

	<p>Bone Holding Forceps HIC-86027</p>	<p>0.00</p>
	<p>Bone Holding Forceps HIC-86026</p>	<p>0.00</p>
	<p>Bone Holding Forceps HIC-86025</p>	<p>0.00</p>
	<p>Bone Holding Forceps HIC-86024</p>	<p>0.00</p>

	<p>Bone Holding Forceps HIC-86023</p>	<p>0.00</p>
	<p>Bone Holding Forceps HIC-86022</p>	<p>0.00</p>
	<p>Bone Holding Forceps HIC-86021</p>	<p>0.00</p>
	<p>Bone Holding Forceps HIC-86020</p>	<p>0.00</p>

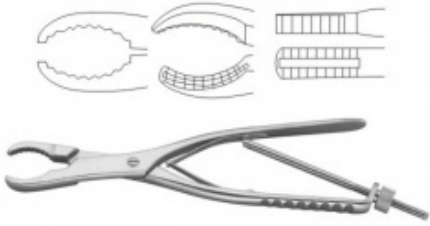
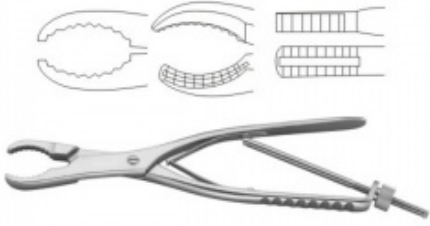
	<p>Bone Holding Forceps HIC-86019</p>	<p>0.00</p>
	<p>Bone Holding Forceps HIC-86018</p>	<p>0.00</p>
	<p>Bone Holding Forceps HIC-86017</p>	<p>0.00</p>
	<p>Bone Holding Forceps HIC-86016</p>	<p>0.00</p>

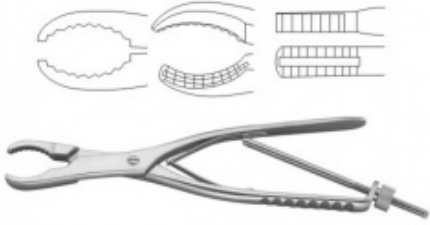
	<p>Bone Holding Forceps HIC-86015</p>	<p>0.00</p>
	<p>Bone Holding Forceps HIC-86014</p>	<p>0.00</p>
	<p>Bone Holding Forceps HIC-86013</p>	<p>0.00</p>
	<p>Bone Holding Forceps HIC-86012</p>	<p>0.00</p>



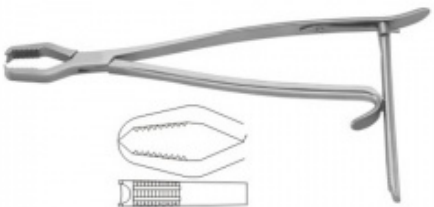

	<p>Bone Holding Forceps HIC-86011</p>	<p>0.00</p>
	<p>Bone Holding Forceps HIC-86010</p>	<p>0.00</p>
	<p>Bone Holding Forceps HIC-86009</p>	<p>0.00</p>
	<p>Bone Holding Forceps HIC-86008</p>	<p>0.00</p>





	<p>Bone Holding Forceps HIC-86007</p>	<p>0.00</p>
	<p>Bone Holding Forceps HIC-86006</p>	<p>0.00</p>
	<p>Bone Holding Forceps HIC-86005</p>	<p>0.00</p>
	<p>Bone Holding Forceps HIC-86004</p>	<p>0.00</p>



	<p>Bone Holding Forceps HIC-86003</p>	<p>0.00</p>
	<p>Bone Holding Forceps HIC-86002</p>	<p>0.00</p>
	<p>Bone Holding Forceps HIC-86001</p>	<p>0.00</p>



Bone Levers

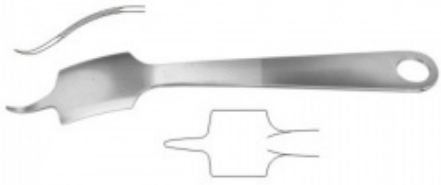
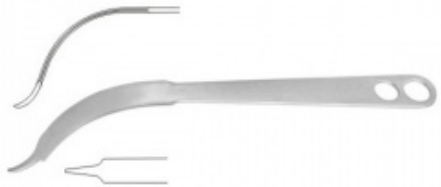

Product Image	Product Name	Price(\$)



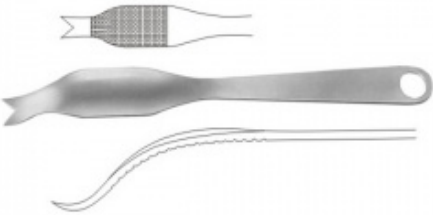

 A metal bone lever with a curved, flat head and a long handle with two finger loops.	Bone Levers HIC-87024	0.00
 A metal bone lever with a curved, flat head and a long handle with two finger loops.	Bone Levers HIC-87023	0.00
 A metal bone lever with a curved, flat head and a long handle with two finger loops.	Bone Levers HIC-87022	0.00
 A metal bone lever with a curved, flat head and a long handle with two finger loops.	Bone Levers HIC-87021	0.00

 A curved metal bone lever with a handle featuring two circular finger loops.	<p>Bone Levers HIC-87020</p>	<p>0.00</p>
 A straight metal bone lever with a handle featuring two circular finger loops.	<p>Bone Levers HIC-87019</p>	<p>0.00</p>
 Two metal bone levers: one curved and one straight, both with handles featuring two circular finger loops.	<p>Bone Levers HIC-87018</p>	<p>0.00</p>
 Two metal bone levers: one curved and one straight, both with handles featuring two circular finger loops.	<p>Bone Levers HIC-87017</p>	<p>0.00</p>

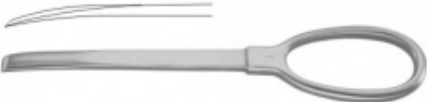

	<p>Bone Levers HIC-87016</p>	<p>0.00</p>
	<p>Bone Levers HIC-87015</p>	<p>0.00</p>
	<p>Bone Levers HIC-87014</p>	<p>0.00</p>
	<p>Bone Levers HIC-87013</p>	<p>0.00</p>





	<p>Bone Levers HIC-87012</p>	<p>0.00</p>
	<p>Bone Levers HIC-87011</p>	<p>0.00</p>
	<p>Bone Levers HIC-87010</p>	<p>0.00</p>
	<p>Bone Levers HIC-87009</p>	<p>0.00</p>

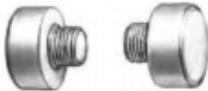

 A long, thin, curved metal instrument with a handle on the left and a curved tip on the right.	Bone Levers HIC-87008	0.00
 A long, thin, curved metal instrument with a handle on the left and a curved tip on the right, similar to HIC-87008 but with a different handle shape.	Bone Levers HIC-87007	0.00
 A long, thin, curved metal instrument with a handle on the left and a curved tip on the right, similar to HIC-87007 but with a different handle shape.	Bone Levers HIC-87006	0.00
 A long, thin, curved metal instrument with a handle on the left and a curved tip on the right, similar to HIC-87006 but with a different handle shape.	Bone Levers HIC-87005	0.00

	<p>Bone Levers HIC-87004</p>	<p>0.00</p>
	<p>Bone Levers HIC-87003</p>	<p>0.00</p>
	<p>Bone Levers HIC-87002</p>	<p>0.00</p>
	<p>Bone Levers HIC-87001</p>	<p>0.00</p>

Bone Mallets



Product Image	Product Name	Price(\$)
	Bone Mallets HIC-88023	0.00
	Bone Mallets HIC-88022	0.00
	Bone Mallets HIC-88021	0.00

 A bone mallet with a cylindrical metal head and a black handle.	Bone Mallets HIC-88020	0.00
 Two small, dark, cylindrical bone mallet heads with threaded ends.	Bone Mallets HIC-88019	0.00
 A bone mallet with a cylindrical metal head and a black handle with a textured grip.	Bone Mallets HIC-88018	0.00
 A bone mallet with a cylindrical metal head and a black handle.	Bone Mallets HIC-88017	0.00



	<p>Bone Mallets HIC-88016</p>	<p>0.00</p>
	<p>Bone Mallets HIC-88015</p>	<p>0.00</p>
	<p>Bone Mallets HIC-88014</p>	<p>0.00</p>
	<p>Bone Mallets HIC-88013</p>	<p>0.00</p>

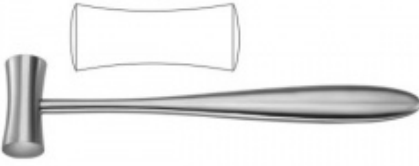
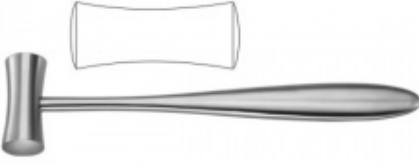



 A bone mallet with a cylindrical metal head and a black, textured handle.	<p>Bone Mallets HIC-88012</p>	<p>0.00</p>
 A bone mallet with a cylindrical metal head and a smooth, tapered handle.	<p>Bone Mallets HIC-88011</p>	<p>0.00</p>
 A circular bone mallet head with a textured, knurled outer edge and a smooth inner surface.	<p>Bone Mallets HIC-88010</p>	<p>0.00</p>
 A bone mallet with a cylindrical metal head and a smooth, tapered handle.	<p>Bone Mallets HIC-88009</p>	<p>0.00</p>



	Bone Mallets HIC-88008	0.00
	Bone Mallets HIC-88007	0.00
	Bone Mallets HIC-88006	0.00
	Bone Mallets HIC-88005	0.00

	<p>Bone Mallets HIC-88004</p>	<p>0.00</p>
	<p>Bone Mallets HIC-88003</p>	<p>0.00</p>
	<p>Bone Mallets HIC-88002</p>	<p>0.00</p>
	<p>Bone Mallets HIC-88001</p>	<p>0.00</p>

Bone Osteotomes



Product Image	Product Name	Price(\$)
 A bone osteotome with a long, straight handle and a flat, rectangular blade. A small diagram above the blade shows its profile.	Bone Osteotomes HIC-89009	0.00
 A bone osteotome with a long, straight handle and a flat, rectangular blade. A small diagram above the blade shows its profile.	Bone Osteotomes HIC-89008	0.00
 A bone osteotome with a long, straight handle and a flat, rectangular blade. A small diagram above the blade shows its profile.	Bone Osteotomes HIC-89007	0.00

 <p>A bone osteotome with a long, tapered handle and a flat, chisel-like blade. A bracket above the blade indicates its width.</p>	<p>Bone Osteotomes HIC-89006</p>	<p>0.00</p>
 <p>A bone osteotome with a long, tapered handle and a flat, chisel-like blade. A bracket above the blade indicates its width.</p>	<p>Bone Osteotomes HIC-89005</p>	<p>0.00</p>
 <p>A bone osteotome with a long, tapered handle and a flat, chisel-like blade. A bracket above the blade indicates its width.</p>	<p>Bone Osteotomes HIC-89004</p>	<p>0.00</p>
 <p>A bone osteotome with a long, tapered handle and a flat, chisel-like blade. A bracket above the blade indicates its width.</p>	<p>Bone Osteotomes HIC-89003</p>	<p>0.00</p>

	<p>Bone Osteotomes HIC-89002</p>	<p>0.00</p>
	<p>Bone Osteotomes HIC-89001</p>	<p>0.00</p>



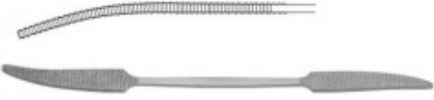

Bone Rasps and Bone Files





Product Image	Product Name	Price(\$)
	<p>Bone Rasps and Bone Files HIC-90004</p>	<p>0.00</p>





	<p>Bone Rasps and Bone Files HIC-90002</p>	<p>0.00</p>
	<p>Bone Rasps and Bone Files HIC-90001</p>	<p>0.00</p>





Bone Reamers and Bone Drills

Product Image	Product Name	Price(\$)
	<p>Bone Reamers and Bone Drills HIC-91018</p>	<p>0.00</p>

	<p>Bone Reamers and Bone Drills HIC-91017</p>	<p>0.00</p>
	<p>Bone Reamers and Bone Drills HIC-91016</p>	<p>0.00</p>
	<p>Bone Reamers and Bone Drills HIC-91015</p>	<p>0.00</p>
	<p>Bone Reamers and Bone Drills HIC-91014</p>	<p>0.00</p>



	<p>Bone Reamers and Bone Drills HIC-91013</p>	<p>0.00</p>
	<p>Bone Reamers and Bone Drills HIC-91012</p>	<p>0.00</p>
	<p>Bone Reamers and Bone Drills HIC-91011</p>	<p>0.00</p>
	<p>Bone Reamers and Bone Drills HIC-91010</p>	<p>0.00</p>



	<p>Bone Reamers and Bone Drills HIC-91009</p>	<p>0.00</p>
	<p>Bone Reamers and Bone Drills HIC-91008</p>	<p>0.00</p>
	<p>Bone Reamers and Bone Drills HIC-91007</p>	<p>0.00</p>
	<p>Bone Reamers and Bone Drills HIC-91006</p>	<p>0.00</p>



	<p>Bone Reamers and Bone Drills HIC-91005</p>	<p>0.00</p>
	<p>Bone Reamers and Bone Drills HIC-91004</p>	<p>0.00</p>
	<p>Bone Reamers and Bone Drills HIC-91003</p>	<p>0.00</p>
	<p>Bone Reamers and Bone Drills HIC-91002</p>	<p>0.00</p>

	<p>Bone Reamers and Bone Drills HIC-91001</p>	<p>0.00</p>
---	---	-------------

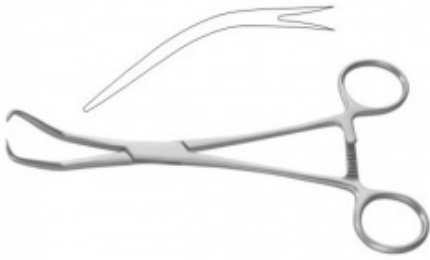
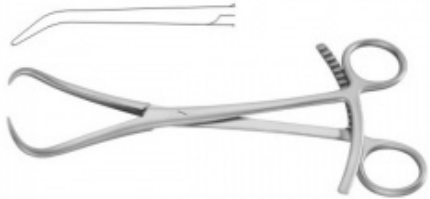
Bone Repositioning Forceps





Product Image	Product Name	Price(\$)
	<p>Bone Repositioning Forceps HIC-92009</p>	<p>0.00</p>
	<p>Bone Repositioning Forceps HIC-92008</p>	<p>0.00</p>





 A pair of surgical forceps with long, curved, beak-like tips and two circular handles. The forceps are shown in a slightly open position.	<p>Bone Repositioning Forceps HIC-92007</p>	<p>0.00</p>
 A pair of surgical forceps with long, curved, beak-like tips and two circular handles. The forceps are shown in a slightly open position.	<p>Bone Repositioning Forceps HIC-92006</p>	<p>0.00</p>
 A pair of surgical forceps with long, curved, beak-like tips and two circular handles. The forceps are shown in a slightly open position.	<p>Bone Repositioning Forceps HIC-92005</p>	<p>0.00</p>
 A pair of surgical forceps with long, curved, beak-like tips and two circular handles. The forceps are shown in a slightly open position.	<p>Bone Repositioning Forceps HIC-92004</p>	<p>0.00</p>





	<p>Bone Repositioning Forceps HIC-92003</p>	<p>0.00</p>
	<p>Bone Repositioning Forceps HIC-92002</p>	<p>0.00</p>
	<p>Bone Repositioning Forceps HIC-92001</p>	<p>0.00</p>



Bone Rongeurs



Product Image	Product Name	Price(\$)

 <p>A pair of bone rongeurs with a curved beak and serrated jaws. A technical drawing of the beak tip is shown above the instrument.</p>	<p>Bone Rongeurs HIC-93018</p>	<p>0.00</p>
 <p>A pair of bone rongeurs with a curved beak and serrated jaws. A technical drawing of the beak tip is shown above the instrument.</p>	<p>Bone Rongeurs HIC-93017</p>	<p>0.00</p>
 <p>A pair of bone rongeurs with a curved beak and serrated jaws. A technical drawing of the beak tip is shown above the instrument.</p>	<p>Bone Rongeurs HIC-93016</p>	<p>0.00</p>
 <p>A pair of bone rongeurs with a curved beak and serrated jaws. A technical drawing of the beak tip is shown above the instrument.</p>	<p>Bone Rongeurs HIC-93015</p>	<p>0.00</p>

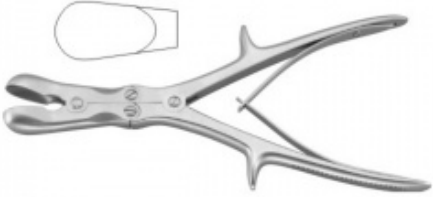
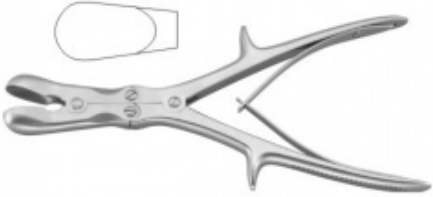
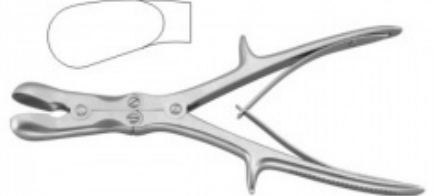
 <p>A pair of bone rongeurs with long, curved handles and a beak-shaped tip. A small inset diagram shows the cross-section of the tip, which is rectangular with a small notch on one side.</p>	<p>Bone Rongeurs HIC-93014</p>	<p>0.00</p>
 <p>A pair of bone rongeurs with long, curved handles and a beak-shaped tip. A small inset diagram shows the cross-section of the tip, which is rectangular with a small notch on one side.</p>	<p>Bone Rongeurs HIC-93013</p>	<p>0.00</p>
 <p>A pair of bone rongeurs with long, curved handles and a beak-shaped tip. The tip has a serrated edge on the lower jaw.</p>	<p>Bone Rongeurs HIC-93012</p>	<p>0.00</p>
 <p>A pair of bone rongeurs with long, curved handles and a beak-shaped tip. A small inset diagram shows the cross-section of the tip, which is rectangular with a small notch on one side.</p>	<p>Bone Rongeurs HIC-93011</p>	<p>0.00</p>

 <p>A pair of bone rongeurs with a long, thin, pointed beak and a curved handle. A small inset diagram shows the cross-section of the beak tip, which is tapered and pointed.</p>	<p>Bone Rongeurs HIC-93010</p>	<p>0.00</p>
 <p>A pair of bone rongeurs with a long, thin, pointed beak and a curved handle. A small inset diagram shows the cross-section of the beak tip, which is tapered and pointed.</p>	<p>Bone Rongeurs HIC-93009</p>	<p>0.00</p>
 <p>A pair of bone rongeurs with a long, thin, pointed beak and a curved handle. A small inset diagram shows the cross-section of the beak tip, which is tapered and pointed.</p>	<p>Bone Rongeurs HIC-93008</p>	<p>0.00</p>
 <p>A pair of bone rongeurs with a long, thin, pointed beak and a curved handle. A small inset diagram shows the cross-section of the beak tip, which is tapered and pointed.</p>	<p>Bone Rongeurs HIC-93007</p>	<p>0.00</p>

	<p>Bone Rongeurs HIC-93006</p>	<p>0.00</p>
	<p>Bone Rongeurs HIC-93005</p>	<p>0.00</p>
	<p>Bone Rongeurs HIC-93004</p>	<p>0.00</p>
	<p>HIC-93001</p>	<p>0.00</p>

	<p>Bone Rongeurs HIC-93002</p>	<p>0.00</p>
	<p>Bone Rongeurs HIC-93003</p>	<p>0.00</p>



Bone Tampers

Product Image	Product Name	Price(\$)
	<p>Bone Tampers HIC-94005</p>	<p>0.00</p>

	<p>Bone Tampers HIC-94004</p>	<p>0.00</p>
	<p>Bone Tampers HIC-94003</p>	<p>0.00</p>
	<p>Bone Tampers HIC-94002</p>	<p>0.00</p>
	<p>Bone Tampers HIC-94001</p>	<p>0.00</p>

Knee Retractors



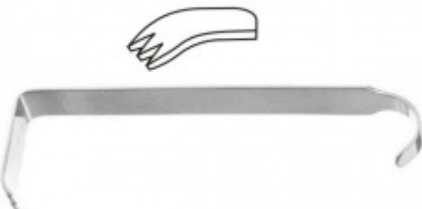

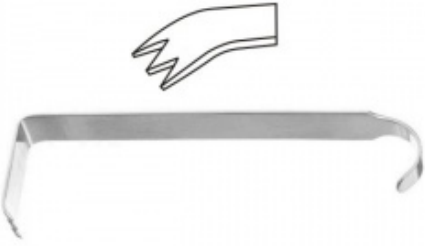
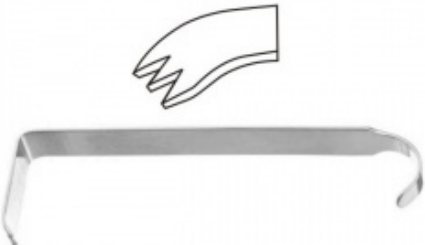
Product Image	Product Name	Price(\$)
 A 3D rendering of a knee retractor. It consists of a long, horizontal, grey, curved bar with a flat, rectangular foot at the left end and a T-shaped base at the right end. A small, thin, curved metal hook is positioned above the main bar.	Knee Retractors HIC-95009	0.00
 A 3D rendering of a knee retractor, similar to HIC-95009. It features a long, horizontal, grey, curved bar with a flat, rectangular foot at the left end and a T-shaped base at the right end. A small, thin, curved metal hook is positioned above the main bar.	Knee Retractors HIC-95008	0.00
 A 3D rendering of a knee retractor, similar to HIC-95009. It features a long, horizontal, grey, curved bar with a flat, rectangular foot at the left end and a T-shaped base at the right end. No hook is visible in this view.	Knee Retractors HIC-95007	0.00





	<p>Knee Retractors HIC-95006</p>	<p>0.00</p>
	<p>Knee Retractors HIC-95005</p>	<p>0.00</p>
	<p>Knee Retractors HIC-95004</p>	<p>0.00</p>
	<p>Knee Retractors HIC-95003</p>	<p>0.00</p>

	<p>Knee Retractors HIC-95002</p>	<p>0.00</p>
	<p>Knee Retractors HIC-95001</p>	<p>0.00</p>



K-Wires





Product Image	Product Name	Price(\$)
	<p>K-Wires HIC-96009</p>	<p>0.00</p>

	<p>K-Wires HIC-96008</p>	<p>0.00</p>
	<p>K-Wires HIC-96007</p>	<p>0.00</p>
	<p>K-Wires HIC-96005</p>	<p>0.00</p>
	<p>K-Wires HIC-96006</p>	<p>0.00</p>

	<p>K-Wires HIC-96004</p>	<p>0.00</p>
	<p>K-Wires HIC-96003</p>	<p>0.00</p>
	<p>K-Wires HIC-96001</p>	<p>0.00</p>
	<p>K-Wires HIC-96002</p>	<p>0.00</p>

Meniscus Knives





Product Image	Product Name	Price(\$)
	Meniscus Knives HIC-97008	0.00
	Meniscus Knives HIC-97007	0.00
	Meniscus Knives HIC-97006	0.00



 A meniscus knife with a long, thin blade and a handle.	Meniscus Knives HIC-97005	0.00
 A meniscus knife with a long, thin blade and a handle.	Meniscus Knives HIC-97004	0.00
 A meniscus knife with a long, thin blade and a handle.	Meniscus Knives HIC-97003	0.00
 A meniscus knife with a long, thin blade and a handle.	Meniscus Knives HIC-97002	0.00

	<p>Meniscus Knives HIC-97001</p>	<p>0.00</p>
---	--------------------------------------	-------------

Nail Instruments



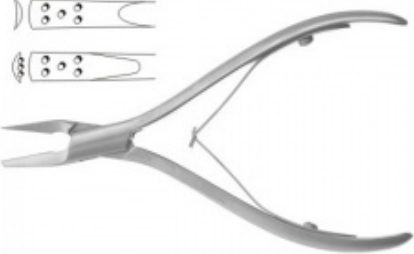

Product Image	Product Name	Price(\$)
	<p>Nail Instruments HIC-98009</p>	<p>0.00</p>
	<p>Nail Instruments HIC-98008</p>	<p>0.00</p>





	Nail Instruments HIC-98007	0.00
	Nail Instruments HIC-98006	0.00
	Nail Instruments HIC-98005	0.00
	Nail Instruments HIC-98004	0.00





	<p>Nail Instruments HIC-98003</p>	<p>0.00</p>
	<p>Nail Instruments HIC-98002</p>	<p>0.00</p>
	<p>Nail Instruments HIC-98001</p>	<p>0.00</p>





Tendon Instruments



Product Image	Product Name	Price(\$)

	Tendon Instruments HIC-99018	0.00
	Tendon Instruments HIC-99017	0.00
	Tendon Instruments HIC-99016	0.00
	Tendon Instruments HIC-99015	0.00

	Tendon Instruments HIC-99014	0.00
	Tendon Instruments HIC-99013	0.00
	Tendon Instruments HIC-99012	0.00
	Tendon Instruments HIC-99011	0.00





	Tendon Instruments HIC-99010	0.00
	Tendon Instruments HIC-99009	0.00
	Tendon Instruments HIC-99008	0.00
	Tendon Instruments HIC-99007	0.00

	<p>Tendon Instruments HIC-99006</p>	<p>0.00</p>
	<p>Tendon Instruments HIC-99005</p>	<p>0.00</p>
	<p>Tendon Instruments HIC-99004</p>	<p>0.00</p>
	<p>Tendon Instruments HIC-99003</p>	<p>0.00</p>

	<p>Tendon Instruments HIC-99002</p>	<p>0.00</p>
	<p>Tendon Instruments HIC-99001</p>	<p>0.00</p>



Twist Drills, Burrs and Trephines

Product Image	Product Name	Price(\$)
	<p>Twist Drills, Burrs and Trephines HIC-100009</p>	<p>0.00</p>

	<p>Twist Drills, Burrs and Trephines HIC-100008</p>	<p>0.00</p>
	<p>Twist Drills, Burrs and Trephines HIC-100007</p>	<p>0.00</p>
	<p>Twist Drills, Burrs and Trephines HIC-100006</p>	<p>0.00</p>
	<p>Twist Drills, Burrs and Trephines HIC-100005</p>	<p>0.00</p>

	<p>Twist Drills, Burrs and Trephines HIC-100004</p>	<p>0.00</p>
	<p>Twist Drills, Burrs and Trephines HIC-100003</p>	<p>0.00</p>
	<p>Twist Drills, Burrs and Trephines HIC-100002</p>	<p>0.00</p>
	<p>Twist Drills, Burrs and Trephines HIC-100001</p>	<p>0.00</p>

Tungsten Carbide Wire Cutting Forceps





Product Image	Product Name	Price(\$)
	Tungsten Carbide Wire Cutting Forceps HIC-OI-102	0.00
	Tungsten Carbide Wire Cutting Forceps HIC-OI-101	0.00



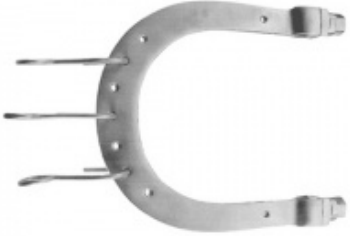

Wire Cutting Forceps

Product Image	Product Name	Price(\$)
	Wire Cutting Forceps HIC-OI-201	0.00

Wire Guides & Extension Bows



Product Image	Product Name	Price(\$)





	<p>Wire Guides & Extension Bows HIC-OI-309</p>	<p>0.00</p>
	<p>Wire Guides & Extension Bows HIC-OI-308</p>	<p>0.00</p>
	<p>Wire Guides & Extension Bows HIC-OI-307</p>	<p>0.00</p>
	<p>Wire Guides & Extension Bows HIC-OI-306</p>	<p>0.00</p>





	<p>Wire Guides & Extension Bows HIC-OI-305</p>	<p>0.00</p>
	<p>Wire Guides & Extension Bows HIC-OI-304</p>	<p>0.00</p>
	<p>Wire Guides & Extension Bows HIC-OI-303</p>	<p>0.00</p>
	<p>Wire Guides & Extension Bows HIC-OI-302</p>	<p>0.00</p>



	<p>Wire Guides & Extension Bows HIC-OI-301</p>	<p>0.00</p>
---	--	-------------

Wire Holding Forceps

Product Image	Product Name	Price(\$)
	<p>Wire Holding Forceps HIC-OI-412</p>	<p>0.00</p>
	<p>Wire Holding Forceps HIC-OI-411</p>	<p>0.00</p>

 <p>Illustration of Wire Holding Forceps HIC-OI-410. The tool has long, curved handles and a fine, serrated tip. A small rectangular inset shows a magnified view of the serrated tip.</p>	<p>Wire Holding Forceps HIC-OI-410</p>	<p>0.00</p>
 <p>Illustration of Wire Holding Forceps HIC-OI-409. The tool has long, curved handles and a serrated tip. Two small rectangular insets show magnified views of the serrated tip.</p>	<p>Wire Holding Forceps HIC-OI-409</p>	<p>0.00</p>
 <p>Illustration of Wire Holding Forceps HIC-OI-408. The tool has long, curved handles and a pointed tip with a textured, mesh-like surface. A small inset shows a magnified view of the textured tip.</p>	<p>Wire Holding Forceps HIC-OI-408</p>	<p>0.00</p>
 <p>Illustration of Wire Holding Forceps HIC-OI-407. The tool has long, curved handles and a pointed tip with a textured, mesh-like surface. A small inset shows a magnified view of the textured tip.</p>	<p>Wire Holding Forceps HIC-OI-407</p>	<p>0.00</p>



 <p>A pair of wire holding forceps with long, curved handles and a pointed, beak-like tip. A small inset image shows a close-up of the tip, which has a fine, serrated texture.</p>	<p>Wire Holding Forceps HIC-OI-406</p>	<p>0.00</p>
 <p>A pair of wire holding forceps with long, curved handles and a pointed tip. A small inset image shows a close-up of the tip, which has a cross-hatched texture.</p>	<p>Wire Holding Forceps HIC-OI-405</p>	<p>0.00</p>
 <p>A pair of wire holding forceps with long, curved handles and a pointed tip. A small inset image shows a close-up of the tip, which has a fine, serrated texture.</p>	<p>Wire Holding Forceps HIC-OI-404</p>	<p>0.00</p>
 <p>A pair of wire holding forceps with long, curved handles and a pointed tip. A small inset image shows a close-up of the tip, which has a fine, serrated texture.</p>	<p>Wire Holding Forceps HIC-OI-403</p>	<p>0.00</p>

	<p>Wire Holding Forceps HIC-OI-402</p>	<p>0.00</p>
	<p>Wire Holding Forceps HIC-OI-401</p>	<p>0.00</p>

PODIATRY INSTRUMENTS



Nail Files and Foot Dressors

Product Image	Product Name	Price(\$)
	<p>Nail Files and Foot Dressors HIC-PI-106</p>	<p>0.00</p>



	Nail Files and Foot Dressors HIC-PI-105	0.00
	Nail Files and Foot Dressors HIC-PI-104	0.00
	Nail Files and Foot Dressors HIC-PI-103	0.00
	Nail Files and Foot Dressors HIC-PI-102	0.00

	<p>Nail Files and Foot Dressors HIC-PI-101</p>	<p>0.00</p>
---	--	-------------

Nail Instruments





Product Image	Product Name	Price(\$)
	<p>Nail Instruments HIC-PI-209</p>	<p>0.00</p>
	<p>Nail Instruments HIC-PI-208</p>	<p>0.00</p>

 A long, thin, tapered metal instrument with a small handle at one end.	<p>Nail Instruments HIC-PI-207</p>	<p>0.00</p>
 A long, thin, tapered metal instrument with a small handle at one end, similar to HIC-PI-207 but with a slightly different handle shape.	<p>Nail Instruments HIC-PI-206</p>	<p>0.00</p>
 A flat, oval-shaped metal instrument with a slightly curved edge.	<p>Nail Instruments HIC-PI-205</p>	<p>0.00</p>
 A metal instrument with a long handle and a textured, cylindrical head.	<p>Nail Instruments HIC-PI-204</p>	<p>0.00</p>



	<p>Nail Instruments HIC-PI-203</p>	<p>0.00</p>
	<p>Nail Instruments HIC-PI-202</p>	<p>0.00</p>
	<p>Nail Instruments HIC-PI-201</p>	<p>0.00</p>

Nail Nippers and Nail Cutters

Product Image	Product Name	Price(\$)

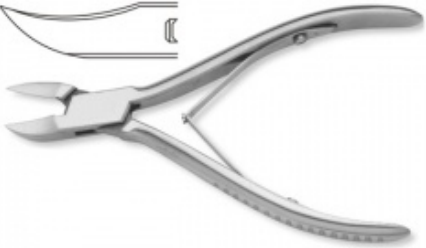
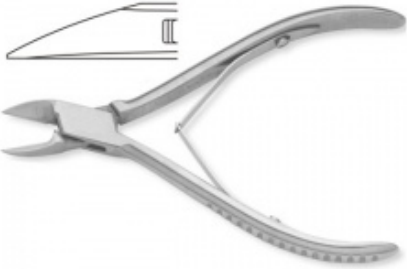
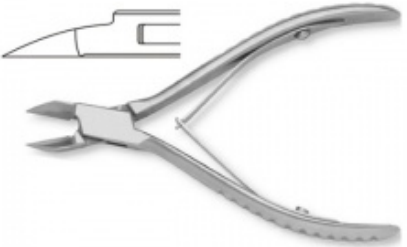
	<p>Nail Nippers and Nail Cutters HIC-PI-315</p>	<p>0.00</p>
	<p>Nail Nippers and Nail Cutters HIC-PI-314</p>	<p>0.00</p>
	<p>Nail Nippers and Nail Cutters HIC-PI-313</p>	<p>0.00</p>
	<p>Nail Nippers and Nail Cutters HIC-PI-312</p>	<p>0.00</p>

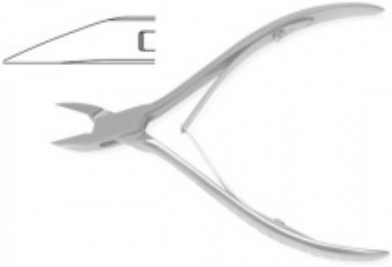
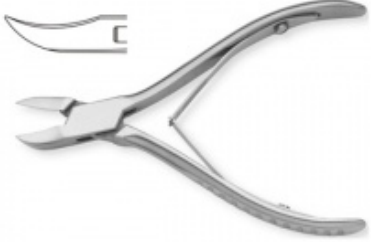
	<p>Nail Nippers and Nail Cutters HIC-PI-311</p>	<p>0.00</p>
	<p>Nail Nippers and Nail Cutters HIC-PI-310</p>	<p>0.00</p>
	<p>Nail Nippers and Nail Cutters HIC-PI-309</p>	<p>0.00</p>
	<p>Nail Nippers and Nail Cutters HIC-PI-308</p>	<p>0.00</p>



	<p>Nail Nippers and Nail Cutters HIC-PI-307</p>	<p>0.00</p>
	<p>Nail Nippers and Nail Cutters HIC-306</p>	<p>0.00</p>
	<p>Nail Nippers and Nail Cutters HIC-PI-305</p>	<p>0.00</p>
	<p>Nail Nippers and Nail Cutters HIC-PI-304</p>	<p>0.00</p>

	<p>Nail Nippers and Nail Cutters HIC-PI-303</p>	<p>0.00</p>
	<p>Nail Nippers and Nail Cutters HIC-PI-302</p>	<p>0.00</p>
	<p>Nail Nippers and Nail Cutters HIC-PI-301</p>	<p>0.00</p>

NEUROSURGERY INSTRUMENTS

Brain Knives

Product Image	Product Name	Price(\$)

	<p>Brain Knives HIC-NI-102</p>	<p>0.00</p>
	<p>Brain Knives HIC-NI-101</p>	<p>0.00</p>

Brain Retractors

Product Image	Product Name	Price(\$)
	<p>Brain Retractors HIC-NI-212</p>	<p>0.00</p>





 A long, thin, curved metal rod with a small black ring or joint near the bend.	<p>Brain Retractors HIC-NI-211</p>	<p>0.00</p>
 A complex metal retractor with a large black circular handle on top, a central shaft, and several horizontal and vertical arms.	<p>Brain Retractors HIC-NI-210</p>	<p>0.00</p>
 A complex metal retractor with a large black circular handle on top, a central shaft, and several horizontal and vertical arms.	<p>Brain Retractors HIC-NI-209</p>	<p>0.00</p>
 A complex metal retractor with multiple curved arms and a central handle, designed for holding surgical instruments.	<p>Brain Retractors HIC-NI-208</p>	<p>0.00</p>

 <p>A 3D rendered image of a brain retractor, model HIC-NI-207. It features a dark, metallic-looking base with a curved, hook-like structure on the left side. Two parallel, slightly curved blades extend from the top of the base, designed to hold a surgical instrument or retractor in place.</p>	<p>Brain Retractors HIC-NI-207</p>	<p>0.00</p>
 <p>A 3D rendered image of a brain retractor, model HIC-NI-206. It consists of a flat, metallic-looking plate with a curved, hook-like base on the left. A central screw mechanism with a T-shaped handle is used to adjust the tension or position of the retractor. A small circular hole is visible on the right side of the plate.</p>	<p>Brain Retractors HIC-NI-206</p>	<p>0.00</p>
 <p>A 3D rendered image of a brain retractor, model HIC-NI-205. It is similar in design to HIC-NI-206, featuring a flat metallic plate with a curved hook base and a central screw with a T-handle. The plate has a more pronounced curve and a different hole placement compared to HIC-NI-206.</p>	<p>Brain Retractors HIC-NI-205</p>	<p>0.00</p>
 <p>A 3D rendered image of a brain retractor, model HIC-OI-204. It is very similar to HIC-NI-206, with a flat metallic plate, a curved hook base, and a central screw with a T-handle. The design is nearly identical to HIC-NI-206 but with slight variations in the plate's shape and hole location.</p>	<p>Brain Retractors HIC-OI-204</p>	<p>0.00</p>



	<p>Brain Retractors HIC-NI-203</p>	<p>0.00</p>
	<p>Brain Retractors HIC-NI-202</p>	<p>0.00</p>
	<p>Brain Retractors HIC-NI-201</p>	<p>0.00</p>

Brain Spatulas

Product Image	Product Name	Price(\$)

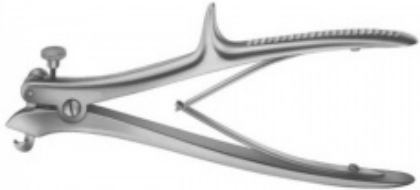

 A simple, flat, rectangular metal spatula with rounded ends.	Brain Spatulas HIC-NI-304	0.00
 A metal spatula with a curved, hook-like tip and a long, thin handle.	Brain Spatulas HIC-NI-303	0.00
 A simple, flat, rectangular metal spatula with rounded ends, similar to HIC-NI-304.	Brain Spatulas HIC-NI-302	0.00
 A metal spatula with a curved tip and a long handle, similar to HIC-NI-303, but with a wider, more rectangular head.	Brain Spatulas HIC-NI-301	0.00

Cranial Rongeurs

Product Image	Product Name	Price(\$)
	Cranial Rongeurs HIC-NI-403	0.00
	Cranial Rongeurs HIC-NI-402	0.00
	Cranial Rongeurs HIC-NI-401	0.00

Dura Elevators

Product Image	Product Name	Price(\$)
---------------	--------------	-----------



	<p>Dura Elevators HIC-NI-502</p>	<p>0.00</p>
	<p>Dura Elevators HIC-NI-501</p>	<p>0.00</p>





Galea Hooks



Product Image	Product Name	Price(\$)
	<p>Galea Hooks HIC-NI-602</p>	<p>0.00</p>

	<p>Galea Hooks HIC-NI-601</p>	<p>0.00</p>
---	-----------------------------------	-------------

Laminectomy Distractors

Product Image	Product Name	Price(\$)
	<p>Laminectomy Distractors HIC-NI-708</p>	<p>0.00</p>
	<p>Laminectomy Distractors HIC-NI-707</p>	<p>0.00</p>





 A long, thin, cylindrical metal instrument with a threaded section and a pointed tip.	Laminectomy Distractors HIC-NI-706	0.00
 A long, thin, cylindrical metal instrument with a threaded section and a pointed tip.	Laminectomy Distractors HIC-NI-705	0.00
 A long, thin, cylindrical metal instrument with a threaded section and a pointed tip.	Laminectomy Distractors HIC-NI-704	0.00
 A metal instrument with a black handle, a curved blade, and a circular component.	Laminectomy Distractors HIC-NI-703	0.00

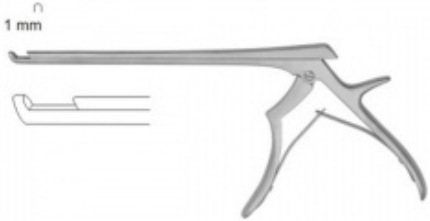

	<p>Laminectomy Distractors HIC-NI-702</p>	<p>0.00</p>
	<p>Laminectomy Distractors HIC-NI-701</p>	<p>0.00</p>

Punches Kerrison Rongeur

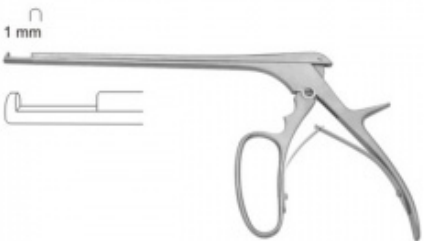
Product Image	Product Name	Price(\$)
	<p>Punches Kerrison Rongeur HIC-NI-812</p>	<p>0.00</p>



	<p>Punches Kerrison Rongeur HIC-NI-811</p>	<p>0.00</p>
	<p>Punches Kerrison Rongeur HIC-NI-810</p>	<p>0.00</p>
	<p>Punches Kerrison Rongeur HIC-NI-809</p>	<p>0.00</p>
	<p>Punches Kerrison Rongeur HIC-NI-808</p>	<p>0.00</p>





	<p>Punches Kerrison Rongeur HIC-NI-807</p>	<p>0.00</p>
	<p>Punches Kerrison Rongeur HIC-NI-806</p>	<p>0.00</p>
	<p>Punches Kerrison Rongeur HIC-NI-805</p>	<p>0.00</p>
	<p>Punches Kerrison Rongeur HIC-NI-804</p>	<p>0.00</p>



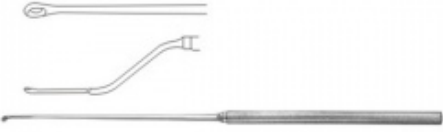

	<p>Punches Kerrison Rongeur HIC-NI-803</p>	<p>0.00</p>
	<p>Punches Kerrison Rongeur HIC-NI-802</p>	<p>0.00</p>
	<p>Punches Kerrison Rongeur HIC-NI-801</p>	<p>0.00</p>



Micro Curettes

Product Image	Product Name	Price(\$)

 The image shows three dental micro-curettes. Two are small, thin instruments with curved tips, and one is a longer, thicker instrument with a straight tip.	<p>Micro Curettes HIC-NI-915</p>	<p>0.00</p>
 The image shows three dental micro-curettes. Two are small, thin instruments with curved tips, and one is a longer, thicker instrument with a straight tip.	<p>Micro Curettes HIC-NI-914</p>	<p>0.00</p>
 The image shows three dental micro-curettes. Two are small, thin instruments with straight tips, and one is a longer, thicker instrument with a straight tip.	<p>Micro Curettes HIC-NI-913</p>	<p>0.00</p>
 The image shows three dental micro-curettes. Two are small, thin instruments with curved tips, and one is a longer, thicker instrument with a straight tip.	<p>Micro Curettes NIC-NI-912</p>	<p>0.00</p>





 <p>Technical drawing of Micro Curettes HIC-NI-911. It shows three views: a top view of the curved tip, a side view of the curved tip, and a full-length view of the instrument with a long handle.</p>	<p>Micro Curettes HIC-NI-911</p>	<p>0.00</p>
 <p>Technical drawing of Micro Curettes HIC-NI-910. It shows a side view of the curved tip and a full-length view of the instrument with a long handle.</p>	<p>Micro Curettes HIC-NI-910</p>	<p>0.00</p>
 <p>Technical drawing of Micro Curettes HIC-NI-909. It shows a side view of the curved tip and a full-length view of the instrument with a long handle.</p>	<p>Micro Curettes HIC-NI-909</p>	<p>0.00</p>
 <p>Technical drawing of Micro Curettes HIC-NI-908. It shows a side view of the curved tip and a full-length view of the instrument with a long handle.</p>	<p>Micro Curettes HIC-NI-908</p>	<p>0.00</p>





 <p>A diagram of a micro-curette with a circular handle and a long, thin shaft that curves downwards and then upwards to a flat, horizontal working tip.</p>	<p>Micro Curettes HIC-NI-907</p>	<p>0.00</p>
 <p>A diagram of a micro-curette with a circular handle and a long, thin shaft that curves downwards and then upwards to a flat, horizontal working tip. The shaft has a slight bend near the handle.</p>	<p>Micro Curettes HIC-NI-906</p>	<p>0.00</p>
 <p>A diagram of a micro-curette with a circular handle and a long, thin shaft that curves downwards and then upwards to a flat, horizontal working tip. The shaft has a slight bend near the handle.</p>	<p>Micro Curettes HIC-NI-905</p>	<p>0.00</p>
 <p>A diagram of a micro-curette with a circular handle and a long, thin shaft that curves downwards and then upwards to a flat, horizontal working tip.</p>	<p>Micro Curettes HIC-NI-904</p>	<p>0.00</p>





	<p>Micro Curettes HIC-NI-903</p>	<p>0.00</p>
	<p>Micro Curettes HIC-NI-902</p>	<p>0.00</p>
	<p>Micro Curettes HIC-NI-901</p>	<p>0.00</p>



Micro Dissectors

Product Image	Product Name	Price(\$)

 A pair of micro dissectors with long, thin handles and curved tips. One handle is shorter than the other.	<p>Micro Dissectors HIC-NI-1015</p>	<p>0.00</p>
 A pair of micro dissectors with long, thin handles and curved tips. The handles are of equal length.	<p>Micro Dissectors HIC-NI-1014</p>	<p>0.00</p>
 A pair of micro dissectors with long, thin handles and curved tips. The handles are of equal length.	<p>Micro Dissectors HIC-NI-1013</p>	<p>0.00</p>
 A pair of micro dissectors with long, thin handles and curved tips. The handles are of equal length.	<p>Micro Dissectors HIC-NI-1012</p>	<p>0.00</p>





 A metal micro-dissector with a long handle and a curved, three-pronged tip.	Micro Dissectors HIC-NI-1011	0.00
 A metal micro-dissector with a long handle and a curved, three-pronged tip.	Micro Dissectors HIC-NI-1010	0.00
 A metal micro-dissector with a long handle and a curved, three-pronged tip.	Micro Dissectors HIC-NI-1009	0.00
 A metal micro-dissector with a long handle and a curved, three-pronged tip.	Micro Dissectors HIC-NI-1008	0.00





	<p>Micro Dissectors HIC-NI-1007</p>	<p>0.00</p>
	<p>Micro Dissectors HIC-NI-1006</p>	<p>0.00</p>
	<p>Micro Dissectors HIC-NI-1005</p>	<p>0.00</p>
	<p>Micro Dissectors HIC-NI-1004</p>	<p>0.00</p>

	<p>Micro Dissectors HIC-NI-1003</p>	<p>0.00</p>
	<p>Micro Dissectors HIC-NI-1002</p>	<p>0.00</p>
	<p>Micro Dissectors HIC-NI-1001</p>	<p>0.00</p>

Micro Knives



Product Image	Product Name	Price(\$)





 A technical drawing of a micro knife with a straight blade and a long handle.	Micro Knives HIC-NI-1109	0.00
 A technical drawing of a micro knife with a curved blade and a long handle.	Micro Knives HIC-NI-1108	0.00
 A technical drawing of a micro knife with a curved blade and a long handle.	Micro Knives HIC-NI-1107	0.00
 A technical drawing of a micro knife with a curved blade and a long handle.	Micro Knives HIC-NI-1106	0.00

 <p>A technical drawing of a micro knife. It features a curved blade with a sharp edge, a handle with a small notch, and a long, thin tail section.</p>	<p>Micro Knives HIC-NI-1105</p>	<p>0.00</p>
 <p>A technical drawing of a micro knife, similar to HIC-NI-1105 but with a slightly different blade curvature.</p>	<p>Micro Knives HIC-NI-1104</p>	<p>0.00</p>
 <p>A technical drawing of a micro knife with a more pronounced curve in the blade.</p>	<p>Micro Knives HIC-NI-1103</p>	<p>0.00</p>
 <p>A technical drawing of a micro knife with a relatively flat blade.</p>	<p>Micro Knives HIC-NI-1102</p>	<p>0.00</p>



	<p>Micro Knives HIC-NI-1101</p>	<p>0.00</p>
---	-------------------------------------	-------------





Micro Needles, Hooks and Spatulas



Product Image	Product Name	Price(\$)
	<p>Micro Needles, Hooks and Spatulas HIC-NI-1206</p>	<p>0.00</p>
	<p>Micro Needles, Hooks and Spatulas HIC-NI-1205</p>	<p>0.00</p>

	<p>Micro Needles, Hooks and Spatulas HIC-NI-1204</p>	<p>0.00</p>
	<p>Micro Needles, Hooks and Spatulas HIC-NI-1203</p>	<p>0.00</p>
	<p>Micro Needles, Hooks and Spatulas HIC-NI-1202</p>	<p>0.00</p>
	<p>Micro Needles, Hooks and Spatulas HIC-NI-1201</p>	<p>0.00</p>

Micro Nerve & Vessel Hooks





Product Image	Product Name	Price(\$)
 A long, thin, metallic surgical hook with a curved tip and a small handle.	Micro Nerve & Vessel Hooks HIC-NI-1309	0.00
 A long, thin, metallic surgical hook with a curved tip and a small handle.	Micro Nerve & Vessel Hooks HIC-NI-1308	0.00
 A long, thin, metallic surgical hook with a curved tip and a small handle.	Micro Nerve & Vessel Hooks HIC-NI-1307	0.00





	<p>Micro Nerve & Vessel Hooks HIC-NI-1306</p>	<p>0.00</p>
	<p>Micro Nerve & Vessel Hooks HIC-NI-1305</p>	<p>0.00</p>
	<p>Micro Nerve & Vessel Hooks HIC-NI-1304</p>	<p>0.00</p>
	<p>Micro Nerve & Vessel Hooks HIC-NI-1303</p>	<p>0.00</p>





	<p>Micro Nerve & Vessel Hooks HIC-NI-1302</p>	<p>0.00</p>
	<p>Micro Nerve & Vessel Hooks HIC-NI-1301</p>	<p>0.00</p>



Micro Raspatories

Product Image	Product Name	Price(\$)
	<p>Micro Raspatories HIC-NI-1415</p>	<p>0.00</p>

 A technical drawing of a micro raspatory. It features a long, thin handle with a dark, textured grip section at the end. The head of the tool has two curved, pointed blades that meet at a central point.	<p>Micro Raspatories HIC-NI-1414</p>	<p>0.00</p>
 A technical drawing of a micro raspatory. It has a long handle with a dark grip section. The head consists of two curved blades that meet at a point, with a slight gap between them.	<p>Micro Raspatories HIC-NI-1412</p>	<p>0.00</p>
 A technical drawing of a micro raspatory, similar to HIC-NI-1414. It has a long handle with a dark grip section and a head with two curved blades meeting at a point.	<p>Micro Raspatories HIC-NI-1413</p>	<p>0.00</p>
 A technical drawing of a micro raspatory, similar to HIC-NI-1412. It has a long handle with a dark grip section and a head with two curved blades meeting at a point.	<p>Micro Raspatories HIC-NI-1411</p>	<p>0.00</p>





 A technical drawing of a raspatory tool. It features a long, thin handle with a small, curved hook at the top. The handle tapers slightly towards the end, which is a flat, rectangular blade.	<p>Micro Raspatories HIC-NI-1410</p>	<p>0.00</p>
 A technical drawing of a raspatory tool. It has a long, thin handle with a small, curved hook at the top. The handle is slightly thicker than the one in the first row. The end is a flat, rectangular blade.	<p>Micro Raspatories HIC-NI-1408</p>	<p>0.00</p>
 A technical drawing of a raspatory tool. It has a long, thin handle with a small, curved hook at the top. The handle is slightly thicker than the one in the first row. The end is a flat, rectangular blade.	<p>Micro Raspatories HIC-NI-1409</p>	<p>0.00</p>
 A technical drawing of a raspatory tool. It has a long, thin handle with a small, curved hook at the top. The handle is slightly thicker than the one in the first row. The end is a flat, rectangular blade.	<p>Micro Raspatories HIC-NI-1407</p>	<p>0.00</p>





	<p>Micro Raspatories HIC-NI-1406</p>	<p>0.00</p>
	<p>Micro Raspatories HIC-NI-1405</p>	<p>0.00</p>
	<p>Micro Raspatories HIC-NI-1304</p>	<p>0.00</p>
	<p>Micro Raspatories HIC-NI-1303</p>	<p>0.00</p>





	<p>Micro Raspatories HIC-NI-1402</p>	<p>0.00</p>
	<p>Micro Raspatories HIC-NI-1401</p>	<p>0.00</p>



Nerve Root Retractors

Product Image	Product Name	Price(\$)
	<p>Nerve Root Retractors HIC-NI-1518</p>	<p>0.00</p>

	<p>Nerve Root Retractors HIC-NI-1517</p>	<p>0.00</p>
	<p>Nerve Root Retractors HIC-NI-1516</p>	<p>0.00</p>
	<p>Nerve Root Retractors HIC-NI-1515</p>	<p>0.00</p>
	<p>Nerve Root Retractors HIC-NI-1514</p>	<p>0.00</p>

	Nerve Root Retractors HIC-NI-1513	0.00
	Nerve Root Retractors HIC-NI-1512	0.00
	Nerve Root Retractors HIC-NI-1511	0.00
	Nerve Root Retractors HIC-NI-1510	0.00



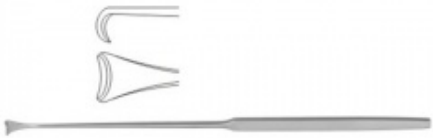

 A metal nerve root retractor with a long, thin shaft that curves into a wide, shallow V-shape at the tip.	Nerve Root Retractors HIC-NI-1509	0.00
 A long, thin, slightly curved metal nerve root retractor with a small hook-like tip.	Nerve Root Retractors HIC-NI-1508	0.00
 A metal nerve root retractor with a long, thin shaft that curves into a hook shape, attached to a thick, ergonomic handle.	Nerve Root Retractors HIC-NI-1506	0.00
 A long, thin, straight metal nerve root retractor with a small hook-like tip.	Nerve Root Retractors HIC-NI-1507	0.00



	<p>Nerve Root Retractors HIC-NI-1505</p>	<p>0.00</p>
	<p>Nerve Root Retractors HIC-NI-1504</p>	<p>0.00</p>
	<p>Nerve Root Retractors HIC-NI-1503</p>	<p>0.00</p>
	<p>Nerve Root Retractors HIC-NI-1501</p>	<p>0.00</p>

	<p>Nerve Root Retractors HIC-NI-1502</p>	<p>0.00</p>
---	--	-------------

Pituitary Instruments





Product Image	Product Name	Price(\$)
	<p>Pituitary Instruments HIC-NI-1909</p>	<p>0.00</p>
	<p>Pituitary Instruments HIC-NI-1908</p>	<p>0.00</p>

	<p>Pituitary Instruments HIC-NI-1907</p>	<p>0.00</p>
	<p>Pituitary Instruments HIC-NI-1906</p>	<p>0.00</p>
	<p>Pituitary Instruments HIC-NI-1905</p>	<p>0.00</p>
	<p>Pituitary Instruments HIC-NI-1904</p>	<p>0.00</p>

	<p>Pituitary Instruments HIC-NI-1903</p>	<p>0.00</p>
	<p>Pituitary Instruments HIC-NI-1902</p>	<p>0.00</p>
	<p>Pituitary Instruments HIC-NI-1901</p>	<p>0.00</p>

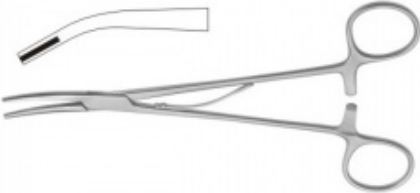

Scalp Clips and Applying Forceps



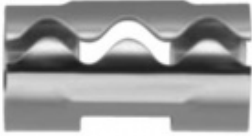

Product Image	Product Name	Price(\$)

	<p>Scalp Clips and Applying Forceps HIC-NI-2005</p>	<p>0.00</p>
	<p>Scalp Clips and Applying Forceps HIC-NI-2004</p>	<p>0.00</p>
	<p>Scalp Clips and Applying Forceps HIC-NI-2003</p>	<p>0.00</p>
	<p>Scalp Clips and Applying Forceps HIC-NI-2002</p>	<p>0.00</p>



	<p>Scalp Clips and Applying Forceps HIC-NI-2001</p>	<p>0.00</p>
---	---	-------------

Traction Tongs

Product Image	Product Name	Price(\$)
	<p>Traction Tongs HIC-NI-2106</p>	<p>0.00</p>
	<p>Traction Tongs HIC-NI-2105</p>	<p>0.00</p>

	<p>Traction Tongs HIC-NI-2104</p>	<p>0.00</p>
	<p>Traction Tongs HIC-NI-2103</p>	<p>0.00</p>
	<p>Traction Tongs HIC-NI-2102</p>	<p>0.00</p>
	<p>Traction Tongs HIC-NI-2101</p>	<p>0.00</p>

Tumor Grasping Forceps

Product Image	Product Name	Price(\$)
	Tumor Grasping Forceps HIC-NI-2202	0.00
	Tumor Grasping Forceps HIC-NI-2201	0.00

Wire Saws

Product Image	Product Name	Price(\$)
	HIC-NI-2303	0.00

	<p>Wire Saws HIC-NI-2302</p>	<p>0.00</p>
	<p>Wire Saws HIC-NI-2301</p>	<p>0.00</p>

OPHTHALMIC INSTRUMENTS



Astigmatism Instruments

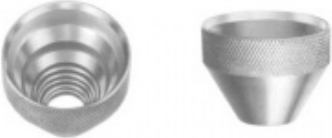



Product Image	Product Name	Price(\$)
	<p>Astigmatism Instruments HIC-OI-503</p>	<p>0.00</p>

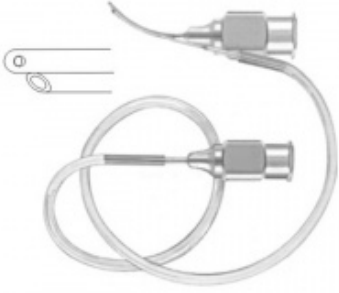
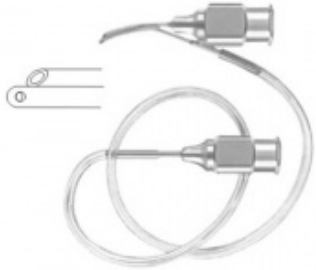



	<p>Astigmatism Instruments HIC-OI-502</p>	<p>0.00</p>
	<p>Astigmatism Instruments HIC-OI-501</p>	<p>0.00</p>





Cannulas



Product Image	Product Name	Price(\$)
	<p>Cannulas HIC-OI-624</p>	<p>0.00</p>



	<p>Cannulas HIC-OI-623</p>	<p>0.00</p>
	<p>Cannulas HIC-OI-622</p>	<p>0.00</p>
	<p>Cannulas HIC-OI-621</p>	<p>0.00</p>
	<p>Cannulas HIC-OI-620</p>	<p>0.00</p>

 A cannula with a long, thin needle and a standard Luer-lock connector. The needle tip is beveled.	<p>Cannulas HIC-OI-619</p>	<p>0.00</p>
 A cannula with a long, thin needle and a standard Luer-lock connector. The needle tip is beveled.	<p>Cannulas HIC-OI-618</p>	<p>0.00</p>
 A cannula with a long, thin needle that is curved at the tip, and a standard Luer-lock connector.	<p>Cannulas HIC-OI-617</p>	<p>0.00</p>
 A cannula with a long, thin needle and a standard Luer-lock connector. The needle tip is beveled.	<p>Cannulas HIC-OI-616</p>	<p>0.00</p>

 A cannula with a long, thin, straight needle and a standard Luer-lock connector.	<p>Cannulas HIC-OI-615</p>	<p>0.00</p>
 A cannula with a short, thin, curved needle and a standard Luer-lock connector.	<p>Cannulas HIC-OI-613</p>	<p>0.00</p>
 A cannula with a long, thin, straight needle and a standard Luer-lock connector.	<p>Cannulas HIC-OI-614</p>	<p>0.00</p>
 A cannula with a short, thin, curved needle and a standard Luer-lock connector.	<p>Cannulas HIC-OI-612</p>	<p>0.00</p>





	<p>Cannulas HIC-OI-611</p>	<p>0.00</p>
	<p>Cannulas HIC-OI-609</p>	<p>0.00</p>
	<p>Cannulas HIC-OI-610</p>	<p>0.00</p>
	<p>Cannulas HIC-OI-608</p>	<p>0.00</p>





 A cannula with a straight shaft and a small, angled side port.	<p>Cannulas HIC-OI-607</p>	<p>0.00</p>
 A cannula with a straight shaft and a larger, curved side port.	<p>Cannulas HIC-OI-605</p>	<p>0.00</p>
 A cannula with a straight shaft and a small, angled side port.	<p>Cannulas HIC-OI-606</p>	<p>0.00</p>
 A cannula with a straight shaft and a small, angled side port.	<p>Cannulas HIC-OI-604</p>	<p>0.00</p>

	<p>Cannulas HIC-OI-603</p>	<p>0.00</p>
	<p>Cannulas HIC-OI-601</p>	<p>0.00</p>
	<p>Cannulas HIC-OI-602</p>	<p>0.00</p>

Corneal Markers

Product Image	Product Name	Price(\$)

	<p>Corneal Markers HIC-OI-709</p>	<p>0.00</p>
	<p>Corneal Markers HIC-OI-708</p>	<p>0.00</p>
	<p>Corneal Markers HIC-OI-707</p>	<p>0.00</p>
	<p>Corneal Markers HIC-OI-706</p>	<p>0.00</p>

 A surgical instrument with a long, thin handle and a circular, serrated tip.	Corneal Markers HIC-OI-705	0.00
 A surgical instrument with a long, thin handle and a circular, serrated tip.	Corneal Markers HIC-OI-704	0.00
 A surgical instrument with a long, thin handle and a circular, serrated tip.	Corneal Markers HIC-OI-703	0.00
 A surgical instrument with a long, thin handle and a circular, serrated tip.	Corneal Markers HIC-OI-702	0.00

	<p>Corneal Markers HIC-OI-701</p>	<p>0.00</p>
---	---------------------------------------	-------------





Depressors





Product Image	Product Name	Price(\$)
	<p>Depressors HIC-OI-804</p>	<p>0.00</p>
	<p>Depressors HIC-OI-803</p>	<p>0.00</p>



	<p>Depressors HIC-OI-802</p>	<p>0.00</p>
	<p>Depressors HIC-OI-801</p>	<p>0.00</p>

Diamond Knives

Product Image	Product Name	Price(\$)
	<p>Diamond Knives HIC-OI-912</p>	<p>0.00</p>





 A diamond knife with a black handle and a silver-colored body. The tip is shown in a cross-section view, revealing a sharp, black diamond tip.	<p>Diamond Knives HIC-OI-911</p>	<p>0.00</p>
 A diamond knife with a black handle and a silver-colored body. The tip is shown in a cross-section view, revealing a sharp, black diamond tip.	<p>Diamond Knives HIC-OI-910</p>	<p>0.00</p>
 A diamond knife with a black handle and a silver-colored body. The tip is shown in a cross-section view, revealing a sharp, black diamond tip.	<p>Diamond Knives HIC-OI-909</p>	<p>0.00</p>
 A diamond knife with a black handle and a silver-colored body. The tip is shown in a cross-section view, revealing a sharp, black diamond tip.	<p>Diamond Knives HIC-OI-908</p>	<p>0.00</p>

 <p>A diamond knife with a long, thin, tapered blade and a black handle. A small inset diagram shows the blade's tip with a dashed line indicating its profile.</p>	<p>Diamond Knives HIC-OI-907</p>	<p>0.00</p>
 <p>A diamond knife with a long, thin, tapered blade and a black handle. A small inset diagram shows the blade's tip with a dashed line indicating its profile.</p>	<p>Diamond Knives HIC-OI-906</p>	<p>0.00</p>
 <p>A diamond knife with a long, thin, tapered blade and a black handle. A small inset diagram shows the blade's tip with a dashed line indicating its profile.</p>	<p>Diamond Knives HIC-OI-905</p>	<p>0.00</p>
 <p>A diamond knife with a long, thin, tapered blade and a black handle. A small inset diagram shows the blade's tip with a dashed line indicating its profile.</p>	<p>Diamond Knives HIC-OI-904</p>	<p>0.00</p>

	<p>Diamond Knives HIC-OI-903</p>	<p>0.00</p>
	<p>Diamond Knives HIC-OI-902</p>	<p>0.00</p>
	<p>Diamond Knives HIC-OI-901</p>	<p>0.00</p>

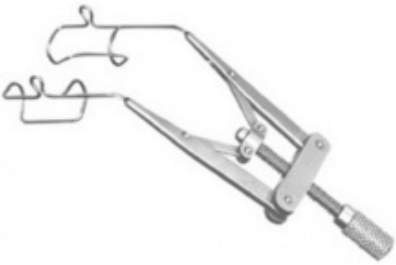

Eye Speculums



Product Image	Product Name	Price(\$)

 A metal eye speculum with a long handle and a curved, adjustable frame for holding the eye open.	Eye Speculums HIC-OI-1024	0.00
 A metal eye speculum with a curved frame and a central adjustment screw.	Eye Speculums HIC-OI-1023	0.00
 A metal eye speculum with a curved frame and a central adjustment screw, similar to HIC-OI-1023 but with a different handle design.	Eye Speculums HIC-OI-1022	0.00
 A metal eye speculum with a curved frame and a central adjustment screw, similar to HIC-OI-1022 but with a different handle design.	Eye Speculums HIC-OI-1021	0.00

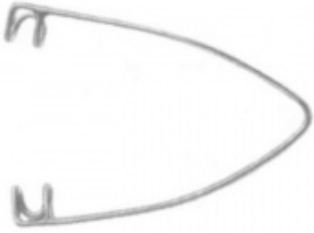
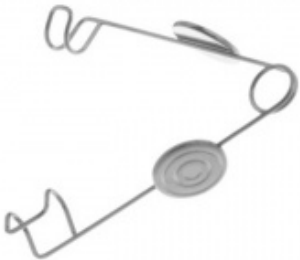
	<p>Eye Speculums HIC-OI-1020</p>	<p>0.00</p>
	<p>Eye Speculums HIC-OI-1019</p>	<p>0.00</p>
	<p>Eye Speculums HIC-OI-1018</p>	<p>0.00</p>
	<p>Eye Speculums HIC-OI-1017</p>	<p>0.00</p>

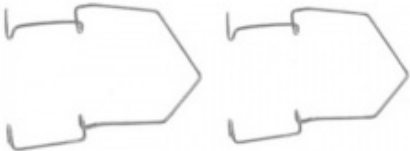

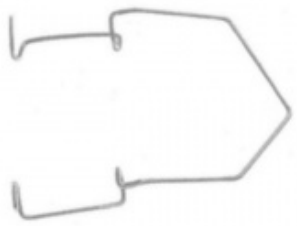
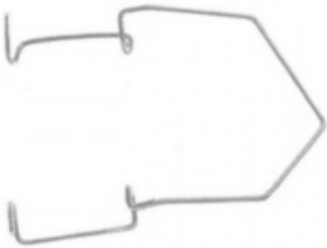
	Eye Speculums HIC-OI-1016	0.00
	Eye Speculums HIC-OI-1015	0.00
	Eye Speculums HIC-OI-1014	0.00
	Eye Speculums HIC-OI-1013	0.00

	<p>Eye Speculums HIC-OI-1012</p>	<p>0.00</p>
	<p>Eye Speculums HIC-OI-1011</p>	<p>0.00</p>
	<p>Eye Speculums HIC-OI-1010</p>	<p>0.00</p>
	<p>Eye Speculums HIC-OI-1009</p>	<p>0.00</p>

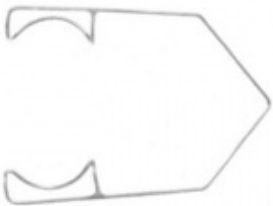
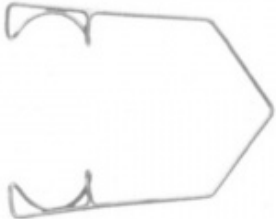
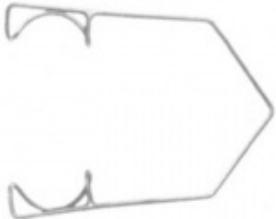
	Eye Speculums HIC-OI-1008	0.00
	Eye Speculums HIC-OI-1007	0.00
	Eye Speculums HIC-OI-1006	0.00
	Eye Speculums HIC-OI-1005	0.00

	Eye Speculums HIC-OI-1004	0.00
	Eye Speculums HIC-OI-1003	0.00
	Eye Speculums HIC-OI-1002	0.00
	Eye Speculums HIC-OI-1001	0.00



Fixation Rings

Product Image	Product Name	Price(\$)
	Fixation Hooks HIC-OI-1106	0.00
	Fixation Hooks HIC-OI-1105	0.00
	Fixation Hooks HIC-OI-1104	0.00

 <p>17 mm</p>	<p>Fixation Rings HIC-OI-1103</p>	<p>0.00</p>
 <p>16 mm</p>	<p>Fixation Rings HIC-OI-1102</p>	<p>0.00</p>
 <p>15 mm</p>	<p>Fixation Rings HIC-OI-1101</p>	<p>0.00</p>

Fixation Hooks





Product Image	Product Name	Price(\$)

	<p>Fixation Hooks HIC-OI-1203</p>	<p>0.00</p>
	<p>Fixation Hooks HIC-OI-1202</p>	<p>0.00</p>
	<p>Fixation Hooks HIC-OI-1201</p>	<p>0.00</p>



IOL Manipulators

Product Image	Product Name	Price(\$)

	<p>IOL Manipulators HIC-OI-1315</p>	<p>0.00</p>
	<p>IOL Manipulators HIC-OI-1314</p>	<p>0.00</p>
	<p>IOL Manipulators HIC-OI-1313</p>	<p>0.00</p>
	<p>IOL Manipulators HIC-OI-1312</p>	<p>0.00</p>





	<p>IOL Manipulators HIC-OI-1311</p>	<p>0.00</p>
	<p>IOL Manipulators HIC-OI-1310</p>	<p>0.00</p>
	<p>IOL Manipulators HIC-OI-1309</p>	<p>0.00</p>
	<p>IOL Manipulators HIC-OI-1308</p>	<p>0.00</p>



 A surgical instrument with a long, thin shaft and a T-shaped handle. The tip is straight.	IOL Manipulators HIC-OI-1307	0.00
 A surgical instrument with a long, thin shaft and a T-shaped handle. The tip is curved.	IOL Manipulators HIC-OI-1306	0.00
 A surgical instrument with a long, thin shaft and a T-shaped handle. The tip is curved.	IOL Manipulators HIC-OI-1305	0.00
 A surgical instrument with a long, thin shaft and a T-shaped handle. The tip is curved.	IOL Manipulators HIC-OI-1304	0.00

	<p>IOL Manipulators HIC-OI-1303</p>	<p>0.00</p>
	<p>IOL Manipulators HIC-OI-1302</p>	<p>0.00</p>
	<p>IOL Manipulators HIC-OI-1301</p>	<p>0.00</p>

Lacrimal Instruments



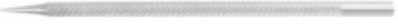

Product Image	Product Name	Price(\$)

 A lacrimal instrument with a long, thin shaft and a hook-like tip.	Lacrimal Instruments HIC-OI-1406	0.00
 A long, thin, tapered lacrimal instrument.	Lacrimal Instruments HIC-OI-1405	0.00
 A long, thin, tapered lacrimal instrument.	Lacrimal Instruments HIC-OI-1404	0.00
 A long, thin, tapered lacrimal instrument.	Lacrimal Instruments HIC-OI-1403	0.00

	<p>Lacrimal Instruments HIC-OI-1402</p>	<p>0.00</p>
	<p>Lacrimal Instruments HIC-OI-1401</p>	<p>0.00</p>



Lens Loops





Product Image	Product Name	Price(\$)
	<p>Lens Loops HIC-OI-1506</p>	<p>0.00</p>

 A long, thin metal tool with a small loop at one end and a tapered handle.	Lens Loops HIC-OI-1505	0.00
 A long, thin metal tool with a small loop at one end and a hook at the other.	Lens Loops HIC-OI-1504	0.00
 A long, thin metal tool with a small loop at one end and a tapered handle.	Lens Loops HIC-OI-1503	0.00
 A long, thin metal tool with a small loop at one end and a tapered handle.	Lens Loops HIC-OI-1502	0.00

	<p>Lens Loops HIC-OI-1501</p>	<p>0.00</p>
---	-----------------------------------	-------------

Muscle Hooks





Product Image	Product Name	Price(\$)
	<p>Muscle Hooks HIC-OI-1609</p>	<p>0.00</p>
	<p>Muscle Hooks HIC-OI-1608</p>	<p>0.00</p>



 A long, thin, cylindrical metal hook with a curved end.	Muscle Hooks HIC-OI-1607	0.00
 A long, thin, cylindrical metal hook with a curved end.	Muscle Hooks HIC-OI-1606	0.00
 A long, thin, cylindrical metal hook with a curved end.	Muscle Hooks HIC-OI-1605	0.00
 A long, thin, cylindrical metal hook with a curved end.	Muscle Hooks HIC-OI-1604	0.00





	<p>Muscle Hooks HIC-OI-1603</p>	<p>0.00</p>
	<p>Muscle Hooks HIC-OI-1602</p>	<p>0.00</p>
	<p>Muscle Hooks HIC-OI-1601</p>	<p>0.00</p>



Nucleus Choppers

Product Image	Product Name	Price(\$)

 A long, thin, cylindrical metal tool with a curved hook at one end and a small notch at the other.	<p>Nucleus Choppers HIC-OI-1715</p>	<p>0.00</p>
 A long, thin, cylindrical metal tool with a curved hook at one end and a small notch at the other, similar to HIC-OI-1715 but with a different notch shape.	<p>Nucleus Choppers HIC-OI-1714</p>	<p>0.00</p>
 A long, thin, cylindrical metal tool with a curved hook at one end and a small notch at the other, similar to HIC-OI-1714 but with a different notch shape.	<p>Nucleus Choppers HIC-OI-1713</p>	<p>0.00</p>
 A long, thin, cylindrical metal tool with a curved hook at one end and a small notch at the other, similar to HIC-OI-1713 but with a different notch shape.	<p>Nucleus Choppers HIC-OI-1712</p>	<p>0.00</p>

 A technical drawing of a long, thin cylindrical component with a central groove. It has a small hook-like feature on the left end and a similar feature on the right end.	<p>Nucleus Choppers HIC-OI-1711</p>	<p>0.00</p>
 A technical drawing of a long, thin cylindrical component with a central groove. It has a small hook-like feature on the left end and a similar feature on the right end.	<p>Nucleus Choppers HIC-OI-1710</p>	<p>0.00</p>
 A technical drawing of a long, thin cylindrical component with a central groove. It has a small hook-like feature on the left end and a similar feature on the right end.	<p>Nucleus Choppers HIC-OI-1709</p>	<p>0.00</p>
 A technical drawing of a long, thin cylindrical component with a central groove. It has a small hook-like feature on the left end and a similar feature on the right end.	<p>Nucleus Choppers HIC-OI-1708</p>	<p>0.00</p>

 A long, thin metal tool with a hook-shaped end. A small inset image shows a close-up of the hook.	Nucleus Choppers HIC-OI-1707	0.00
 A long, thin metal tool with a hook-shaped end. A small inset image shows a close-up of the hook.	Nucleus Choppers HIC-OI-1706	0.00
 A long, thin metal tool with a hook-shaped end. A small inset image shows a close-up of the hook.	Nucleus Choppers HIC-OI-1705	0.00
 A long, thin metal tool with a hook-shaped end. A small inset image shows a close-up of the hook.	Nucleus Choppers HIC-OI-1704	0.00

 A technical drawing of a long, thin metal tool with a bent tip. A small inset shows a magnified view of the tip's curvature.	<p>Nucleus Choppers HIC-OI-1703</p>	<p>0.00</p>
 A technical drawing of a long, thin metal tool with a bent tip. A small inset shows a magnified view of the tip's curvature.	<p>Nucleus Choppers HIC-OI-1702</p>	<p>0.00</p>
 A technical drawing of a long, thin metal tool with a bent tip. A small inset shows a magnified view of the tip's curvature.	<p>Nucleus Choppers HIC-OI-1701</p>	<p>0.00</p>